



لارا العربية التجارية
LARA AL ARABIA TRADING

DRAPES

AUTHORIZED DEALERS
IN SAFECARE MEDICALS





لارا العربية التجارية
LARA AL ARABIA TRADING

Table of Content

Standard Drapes	
Adhesive Drapes.....	
Reinforced Adhesive Drapes.....	
Fenestrated Drapes.....	
Poly Drapes.....	
Adhesive Poly Drapes.....	
Reinforced Adhesive Poly Drapes.....	
Fenestrated Poly Drapes.....	
Standard Viscose Drape.....	
Adhesive Viscose Drape.....	
Fenestrated Viscose Drape.....	
Standard Transparent Sheet.....	
Adhesive Transparent Sheet.....	
Fenestrated Transparent Sheet.....	
Sterile Reinforcement Sheet.....	
Sterile Fenestrated Reinforcement Sheet.....	
Speciality Drapes.....	

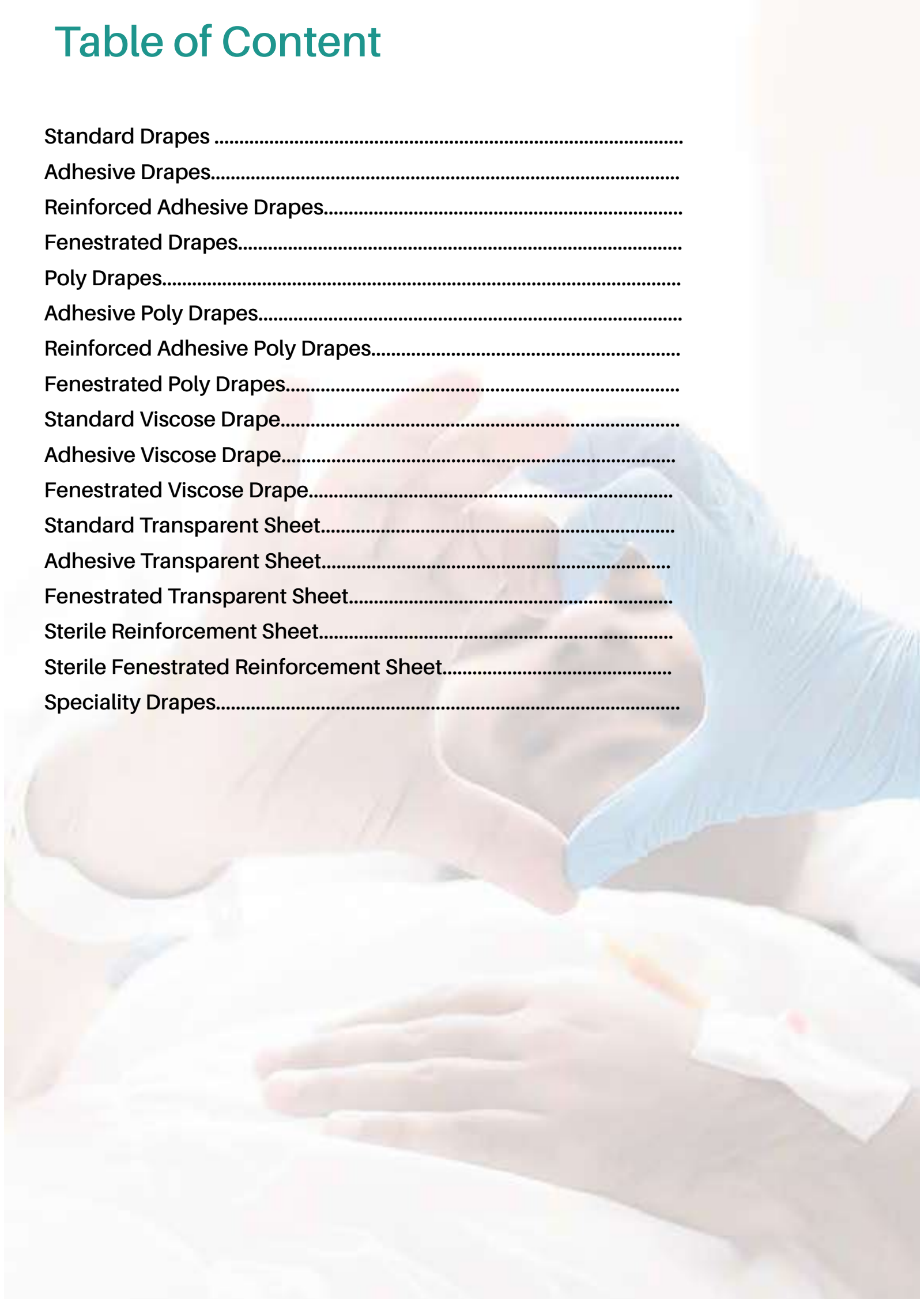

Standard Drapes

CDS-SMI

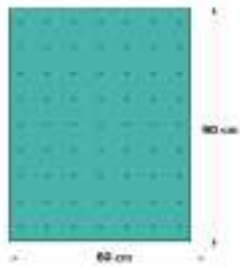

CDS-004

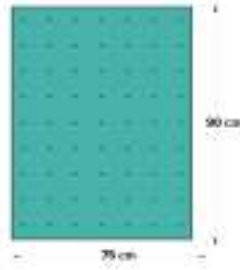

CDS-005

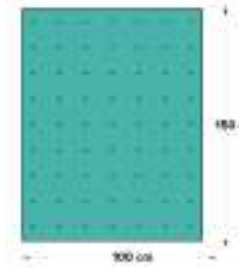

CDS-006

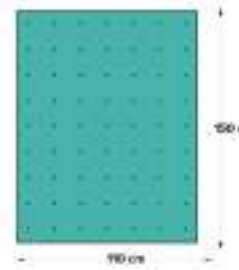

CDS-007

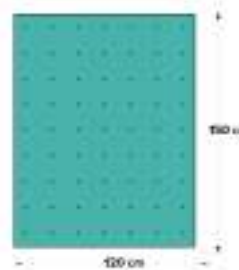

CDS-008

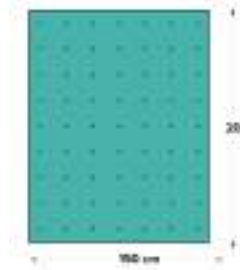

CDS-009

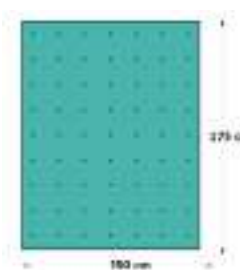

CDS-010

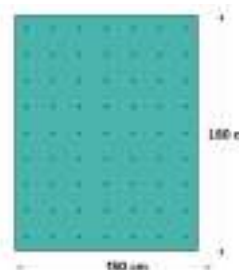

CDS-011

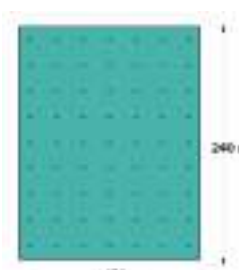

CDS-012

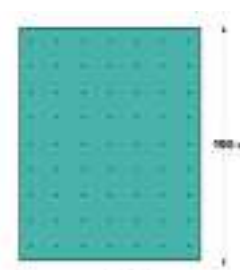

CDS-013

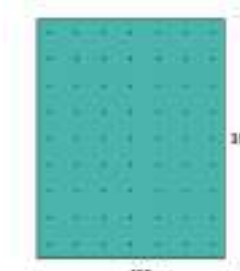

CDS-014

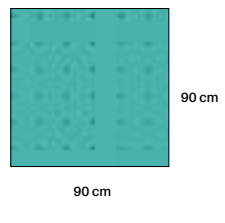

CDS-015

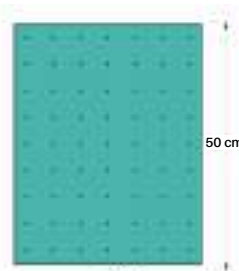

CDS-016

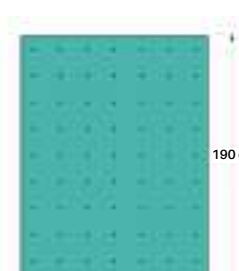

CDS-018

REF	DESCRIPTION
CDS-004	STERILE DRAPE 60 CM X 90 CM
CDS-005	STERILE DRAPE 75 CM X90 CM
CDS-006	STERILE DRAPE 100 CM X 150 CM
CDS-007	STERILE DRAPE 110 CM X 150 CM
CDS-008	STERILE DRAPE 120 CM X 150 CM
CDS-009	STERILE DRAPE 150 CM X 200 CM
CDS-010	STERILE DRAPE 150 CM X 175 CM
CDS-011	STERILE DRAPE 150 CM X 180 CM
CDS-012	STERILE DRAPE 150 CM X 240 CM
CDS-013	STERILE DRAPE 120 CM X 190 CM
CDS-014	STERILE DRAPE 120 CM X 180 CM
CDS-015	STERILE DRAPE 90 CM X 90 CM
CDS-016	STERILE DRAPE 60 CM X 50 CM
CDS-018	STERILE DRAPE 150 CM X 190 CM

Fabric Materials :

Adhesive Drapes

CAD-SMI

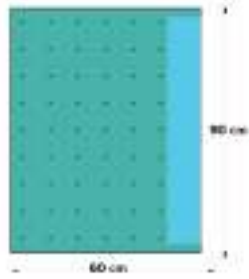

CAD-011

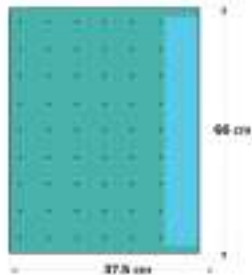

CAD-012

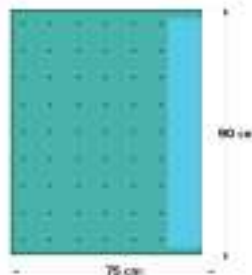

CAD-014

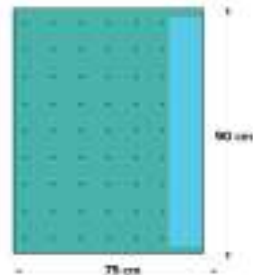

CAD-015

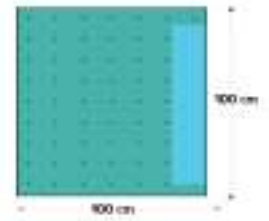

CAD-016

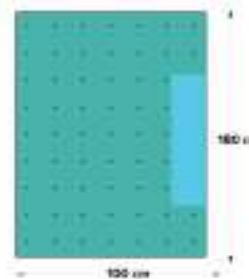

CAD-017

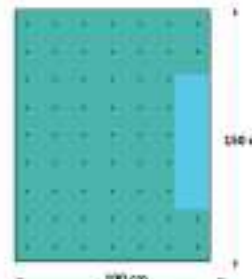

CAD-018

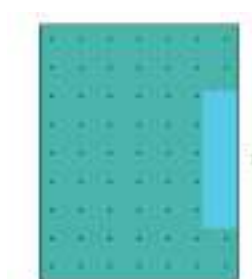

CAD-019

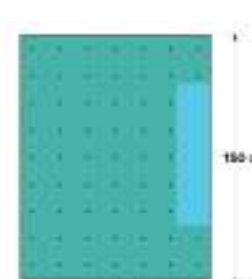

CAD-020

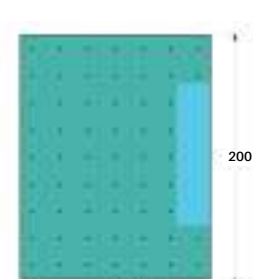

CAD-021

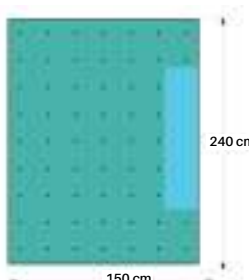

CAD-025

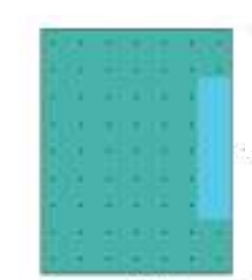

CAD-026

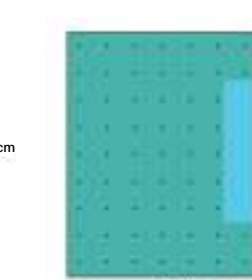

CAD-029

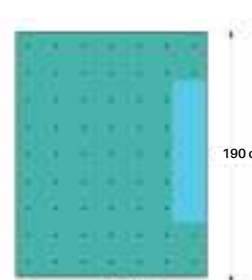

CAD-030

REF	DESCRIPTION
CAD-011	STERILE ADHESIVE DRAPE 60 CM X 90 CM
CAD-012	STERILE ADHESIVE DRAPE 66 CM 37.5 CM
CAD-014	STERILE ADHESIVE DRAPE 75 CM X 90 CM
CAD-015	STERILE ADHESIVE DRAPE 75 CM X 90 CM)
CAD-016	STERILE ADHESIVE DRAPE 100 CM X 100 CM
CAD-017	STERILE ADHESIVE DRAPE 100 X 180 CM
CAD-018	STERILE ADHESIVE DRAPE 100 CM X 150 CM
CAD-019	STERILE ADHESIVE DRAPE 150 CM X 175 CM
CAD-020	STERILE ADHESIVE DRAPE 120 CM X 150 CM
CAD-021	STERILE ADHESIVE DRAPE 150 CM X 200 CM
CAD-025	STERILE ADHESIVE DRAPE 150 CM X 240 CM
CAD-026	STERILE ADHESIVE DRAPE 120 CM X 200 CM
CAD-029	STERILE ADHESIVE DRAPE 90 CM X 100 CM
CAD-030	STERILE ADHESIVE DRAPE 120 CM X 190 CM

Fabric Materials :

Reinforced Adhesive Drapes

CRD-SMI

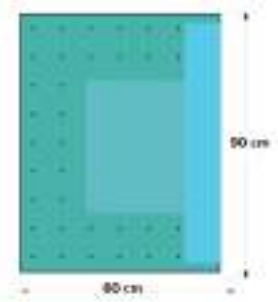

CRD-004

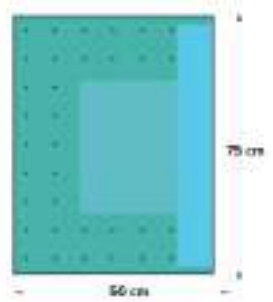

CRD-005

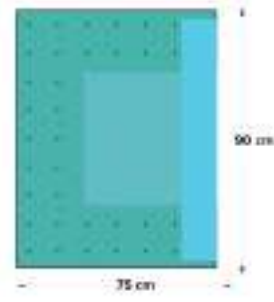

CRD-006

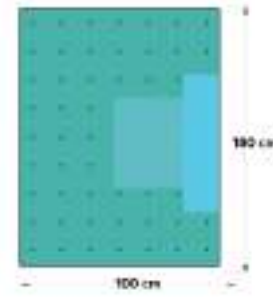

CRD-007

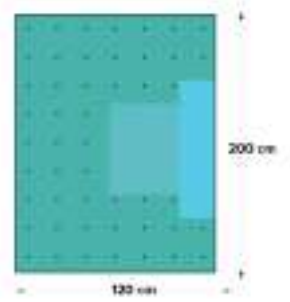

CRD-009

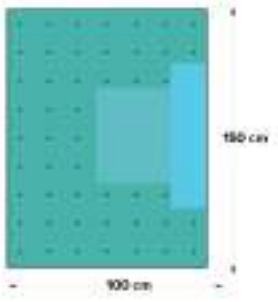

CRD-010

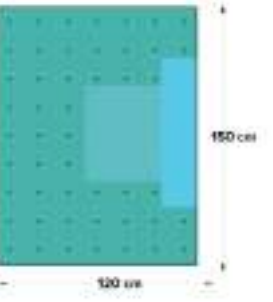

CRD-011

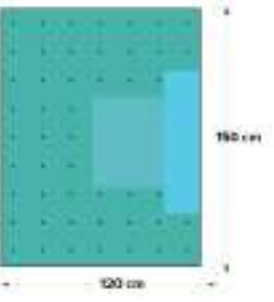

CRD-012

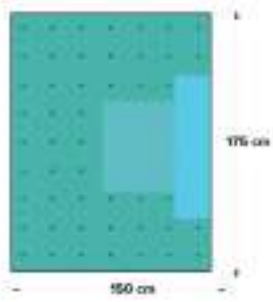

CRD-013

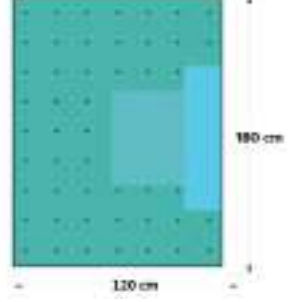

CRD-008

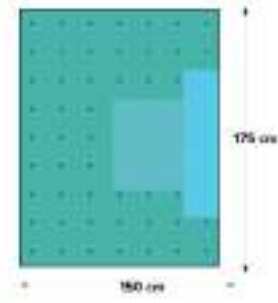

CRD-014

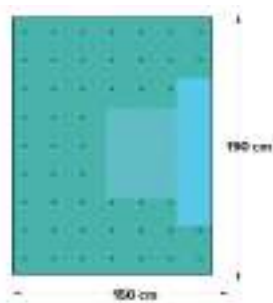

CRD-015

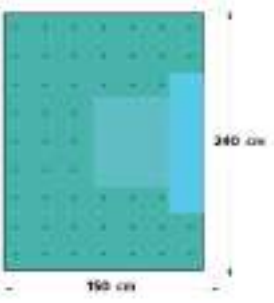

CRD-016

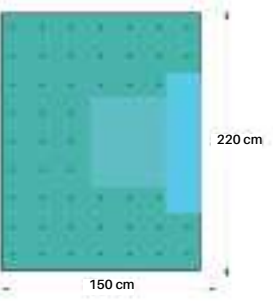

CRD-017

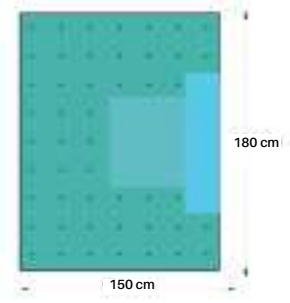

CRD-018

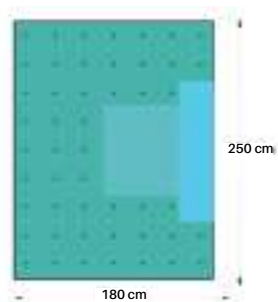

CRD-019

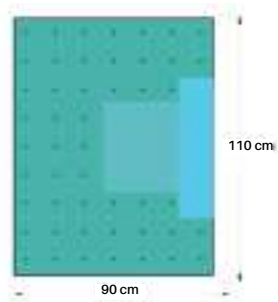

CRD-020

REF	DESCRIPTION
CRD-004	STERILE REINFORCED ADHESIVE DRAPE 60 CM X 90 CM
CRD-005	STERILE REINFORCED ADHESIVE DRAPE 50 CM X 75 CM
CRD-006	STERILE REINFORCED ADHSEIVE DRAPE 75 CM X 90 CM
CRD-007	STERILE REINFORCED ADHESIVE DRAPE 100 CM X 180 CM
CRD-008	STERILE REINFORCED ADHESIVE DRAPE 120 CM X 180 CM
CRD-009	STERILE REINFORCED ADHESIVE DRAPE 120 CM X 200 CM
CRD-010	STERILE REINFORCED ADHSEIVE DRAPE 100 CM X 150 CM
CRD-011	STERILE REINFORCED ADHESIVE DRAPE 120 CM X 150 CM
CRD-012	STERILE REINFORCED ADHESIVE DRAPE 150 CM X 120 CM
CRD-013	STERILE REINFORCED ADHESIVE DRAPE 150 CM X 175 CM
CRD-014	STERILE REINFORCED ADHESIVE DRAPE 150 CM X 175 CM
CRD-015	STERILE REINFORCED ADHESIVE DRAPE 150 CM X 190 CM
CRD-016	STERILE REINFORCED ADHESIVE DRAPE 150 CM X 240 CM
CRD-017	STERILE REINFORCED ADHESIVE DRAPE 150 CM X 220 CM
CRD-018	STERILE REINFORCED ADHESIVE DRAPE 150 CM X 180 CM
CRD-019	STERILE REINFORCED ADHESIVE DRAPE 180 CM X 250 CM
CRD-020	STERILE REINFORCED ADHESIVE DRAPE 90 CM X 110 CM

Fabric Materials :

- SMS
- Adhesive
- SMS + PE Coated
- Absorbent Non-woven (Reinforcement)
- Transparent Sheet
- Viscose + PE

Fenestrated Drapes

CFD-SMI



CFD-004

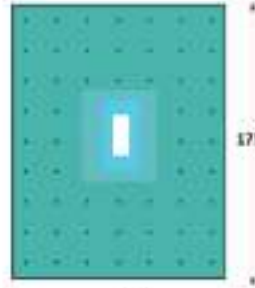

CFD-008

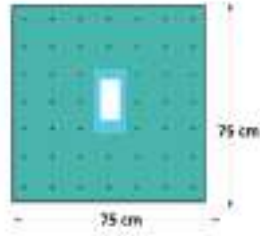

CFD-011

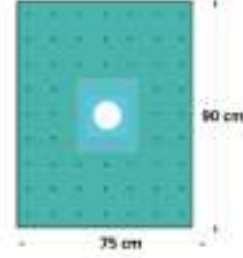

CFD-013

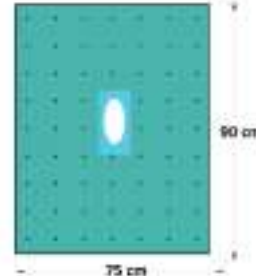

CFD-015

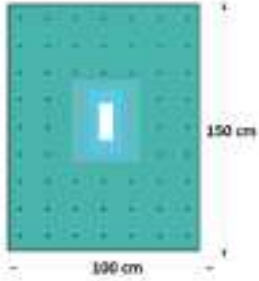

CFD-020

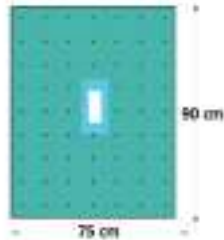

CFD-014

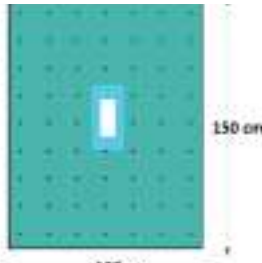

CFD-021

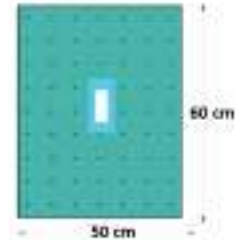

CFD-005

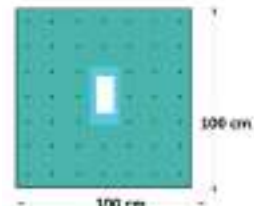

CFD-023

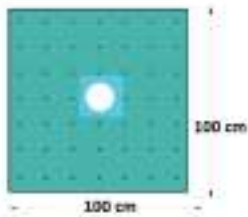

CFD-024

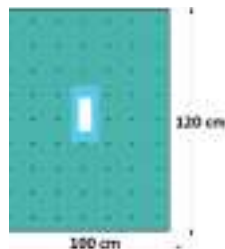

CFD-025

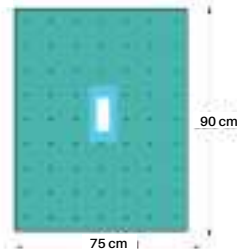

CFD-014

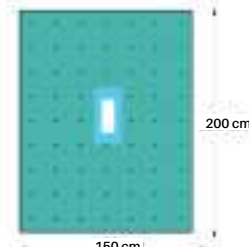

CFD-026

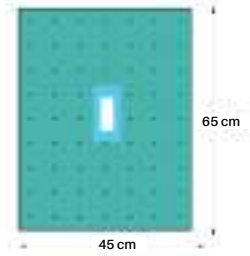

CFD-034

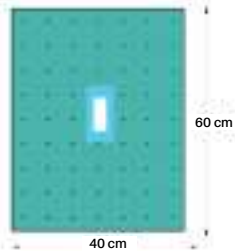

CFD-035

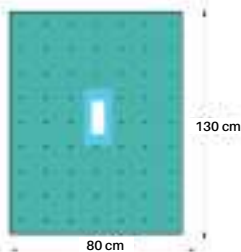

CFD-044

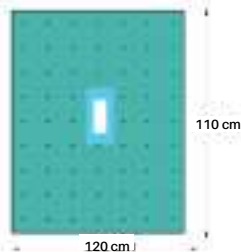

CFD-054

REF	DESCRIPTION
CFD-004	STERILE FENESTRATED DRAPE 60 X 45 CM
CFD-008	STERILE FENESTRATED DRAPE 75 X 175 CM
CFD-011	STERILE FENESTRATED DRAPE 75 X 75
CFD-013	STERILE FENESTRATED DRAPE 75 X 90
CFD-015	STERILE FENESTRATED DRAPE 75 X 90
CFD-020	STERILE FENESTRATED DRAPE 100 X 150
CFD-021	STERILE FENESTRATED DRAPE 100 X 150
CFD-005	STERILE FENESTRATED DRAPE 60 X 50
CFD-023	STERILE FENESTRATED DRAPE 100 X 100
CFD-024	STERILE FENESTRATED DRAPE 100 X 100
CFD-025	STERILE FENESTRATED DRAPE 120 X 100
CFD-014	STERILE FENESTRATED DRAPE 75 X 90
CFD-026	STERILE FENESTRATED DRAPE 150 X 200
CFD-034	STERILE FENESTRATED DRAPE 45 X 65
CFD-035	STERILE FENESTRATED DRAPE 40 X 60
CFD-044	STERILE FENESTRATED DRAPE 80 X 130
CFD-054	STERILE FENESTRATED DRAPE 120 X 110

Fabric Materials :

- SMS
- Adhesive
- SMS + PE Coated
- Absorbent Non-woven Reinforcement
- Transparent Sheet
- Viscose + PE

Poly Drapes

CPD-SMI

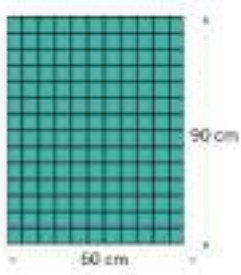

CPD-001

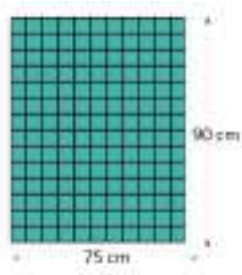

CPD-002

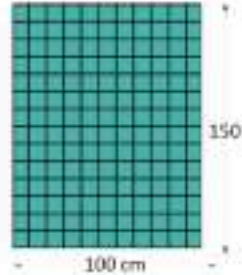

CPD-004

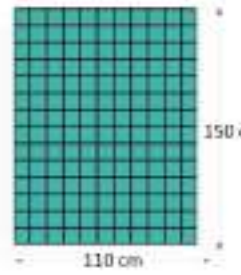

CPD-005

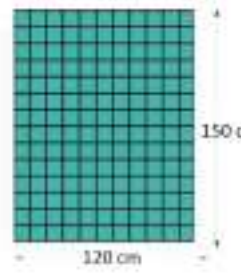

CPD-006

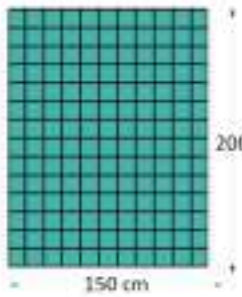

CPD-007

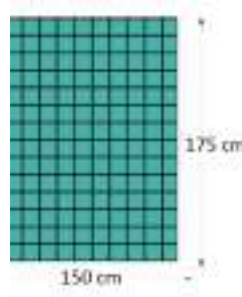

CPD-008

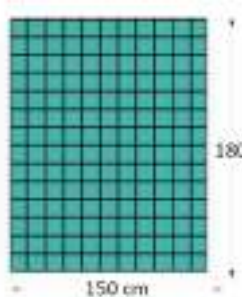

CPD-009

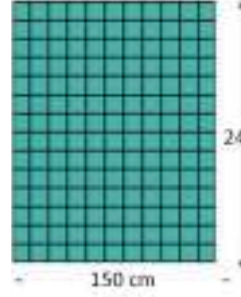

CPD-010

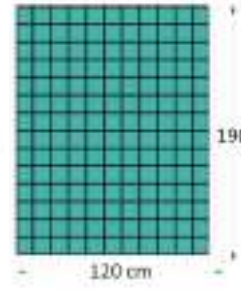

CPD-011

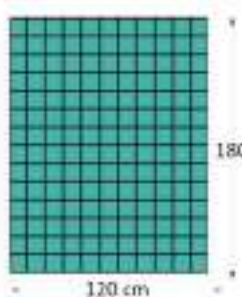

CPD-012

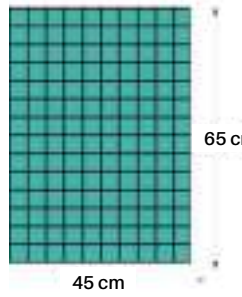

CPD-013

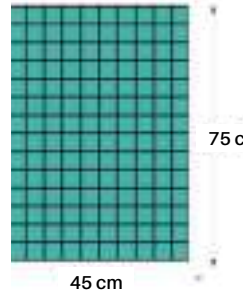

CPD-014

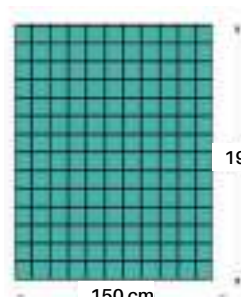

CPD-015

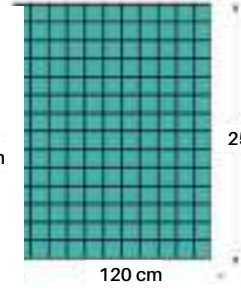

CPD-017

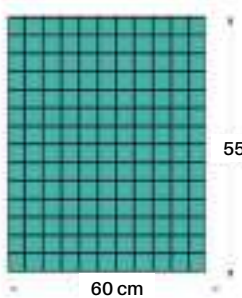

CPD-018

REF	DESCRIPTION
CPD-001	STERILE POLY DRAPE 60 CM X 90 CM
CPD-002	STERILE POLY DRAPE 75 CM X 90 CM
CPD-004	STERILE POLY DRAPE 100 CM X 150 CM
CPD-005	STERILE POLY DRAPE 110 CM X 150 CM
CPD-006	STERILE POLY DRAPE 120 CM X 150 CM
CPD-007	STERILE POLY DRAPE 150 CM X 200 CM
CPD-008	STERILE POLY DRAPE 150 CM X 175 CM
CPD-009	STERILE POLY DRAPE 150 CM X 180 CM
CPD-010	STERILE POLY DRAPE 150 CM X 240 CM
CPD-011	STERILE POLY DRAPE 120 CM X 190 CM
CPD-012	STERILE POLY DRAPE 120 CM X 180 CM
CPD-013	STERILE POLY DRAPE 65 CM X 45 CM
CPD-014	STERILE POLY DRAPE 45 CM X 75 CM
CPD-015	STERILE POLY DRAPE 150 CM X 190 CM
CPD-017	STERILE POLY DRAPE 120 CM X 250 CM
CPD-018	STERILE POLY DRAPE 60 CM X 55 CM

Fabric Materials :

Adhesive Poly Drapes

CPA-SMI

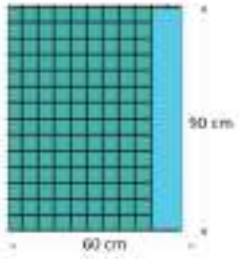

CPA-005

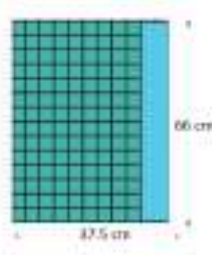

CPA-006

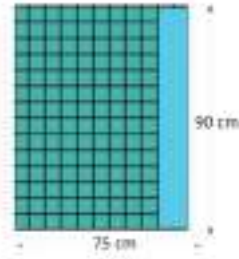

CPA-007

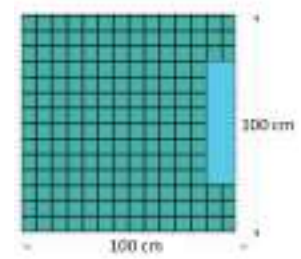

CPA-009

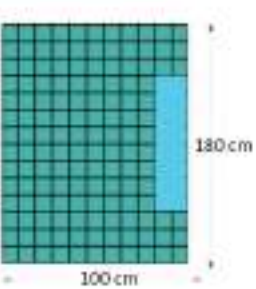

CPA-010

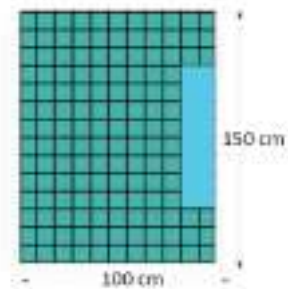

CPA-011

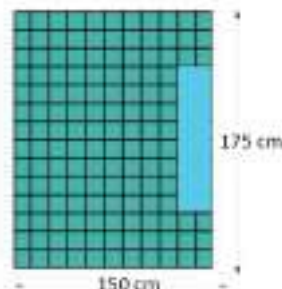

CPA-012

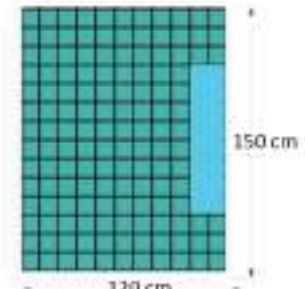

CPA-013

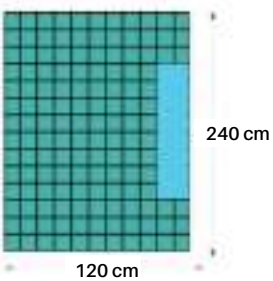

CPA-018

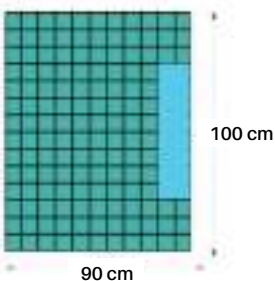

CPA-019

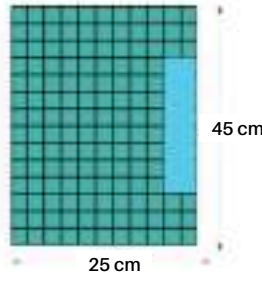

CPA-021

REF	DESCRIPTION
CPA-005	STERILE ADHESIVE POLY DRAPE 60 CM X 90 CM
CPA-006	STERILE ADHESIVE POLY DRAPE 66 CM 37.5 CM
CPA-007	STERILE ADHESIVE POLY DRAPE 75 CM X 90 CM
CPA-009	STERILE ADHESIVE POLY DRAPE 100 CM X 100 CM
CPA-010	STERILE ADHESIVE POLY DRAPE 100 X 180 CM
CPA-011	STERILE ADHESIVE POLY DRAPE 100 CM X 150 CM
CPA-012	STERILE ADHESIVE POLY DRAPE 150 CM X 175 CM
CPA-013	STERILE ADHESIVE POLY DRAPE 120 CM X 150 CM
CPA-018	STERILE ADHESIVE POLY DRAPE 120 CM X 240 CM
CPA-019	STERILE ADHESIVE POLY DRAPE 90 CM X 100 CM
CPA-021	STERILE ADHESIVE POLY DRAPE 45 CM X 25 CM

Fabric Materials :



SMS



Adhesive



SMS + PE Coated



Absorbent Non-woven (Reinforcement)



Transparent Sheet



Viscose + PE



Reinforced Adhesive Poly Drapes

CRP-SMI

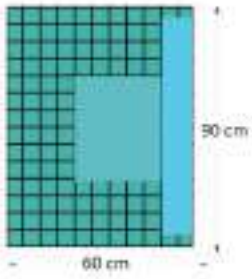

CRP-001

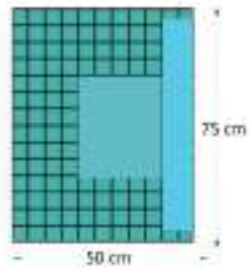

CRP-002

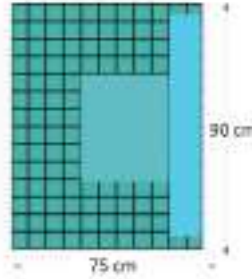

CRP-003

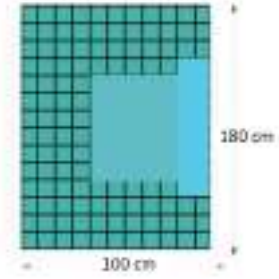

CRP-004

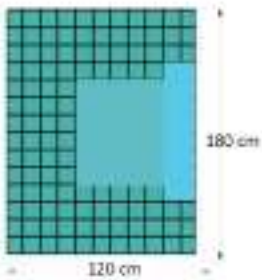

CRP-005

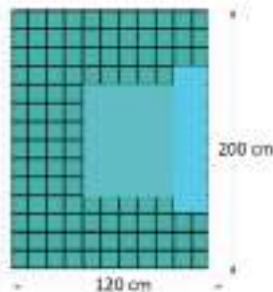

CRP-006

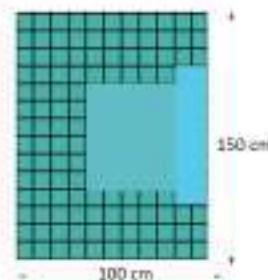

CRP-007

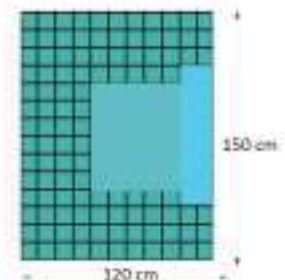

CRP-008

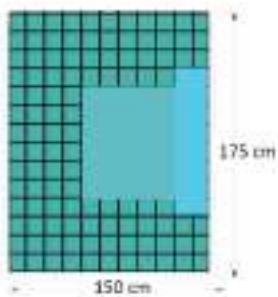

CRP-009

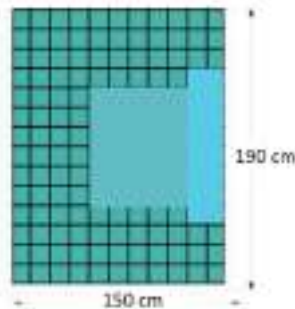

CRP-010

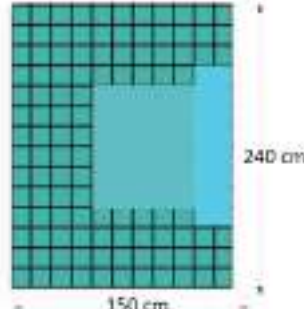

CRP-011

REF	DESCRIPTION
CRP-001	STERILE REINFORCED ADHESIVE POLY DRAPE 60 CM X 90 CM
CRP-002	STERILE REINFORCED ADHESIVE POLY DRAPE 50 CM X 75 CM
CRP-003	STERILE REINFORCED ADHESIVE POLY DRAPE 75 CM X 90 CM
CRP-004	STERILE REINFORCED ADHESIVE POLY DRAPE 100 CM X 180 CM
CRP-005	STERILE REINFORCED ADHESIVE POLY DRAPE 120 CM X 180 CM
CRP-006	STERILE REINFORCED ADHESIVE POLY DRAPE 120 CM X 200 CM
CRP-007	STERILE REINFORCED ADHESIVE POLY DRAPE 100 CM X 150 CM
CRP-008	STERILE REINFORCED ADHESIVE POLY DRAPE 120 CM X 150 CM
CRP-009	STERILE REINFORCED ADHESIVE POLY DRAPE 150 CM X 175 CM
CRP-010	STERILE REINFORCED ADHESIVE POLY DRAPE 150 CM X 190 CM
CRP-011	STERILE REINFORCED ADHESIVE POLY DRAPE 150 CM X 240 CM

Fabric Materials :



SMS



Adhesive



SMS + PE Coated



Absorbent Non-woven (Reinforcement)



Transparent Sheet



Viscose + PE



Fenestrated Poly Drapes CFP-SMI

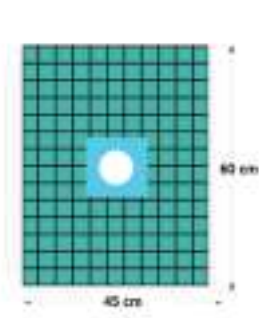

CFP-001

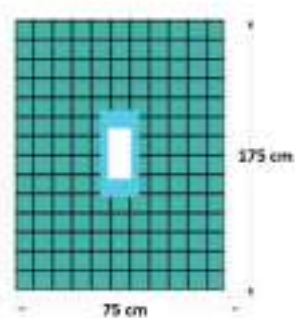

CFP-002

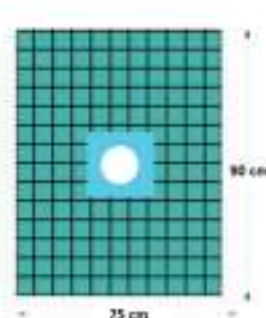

CFP-003

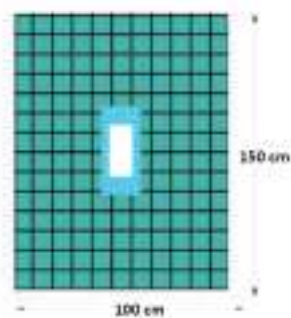

CFP-005

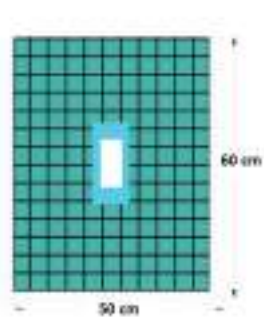

CFP-006

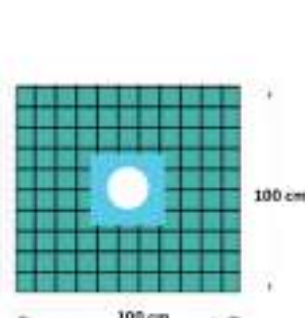

CFP-007

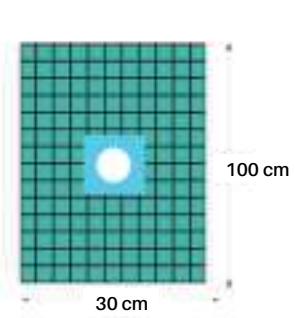

CFP-031

REF	DESCRIPTION
CFP-001	STERILE FENESTRATED POLY DRAPE 60 X 45 CM
CFP-002	STERILE FENESTRATED POLY DRAPE 75 X 175 CM
CFP-003	STERILE FENESTRATED POLY DRAPE 75 X 90
CFP-005	STERILE FENESTRATED POLY DRAPE 100 X 150
CFP-006	STERILE FENESTRATED POLY DRAPE 60 X 50
CFP-007	STERILE FENESTRATED POLY DRAPE 100 X 100
CFP-031	STERILE FENESTRATED POLY DRAPE 30 X 100

Fabric Materials :

- SMS
- Adhesive
- SMS + PE Coated
- Absorbent Non-woven (Reinforcement)
- Transparent Sheet
- Viscose + PE

Standard Viscose Drape

CVS-SMI

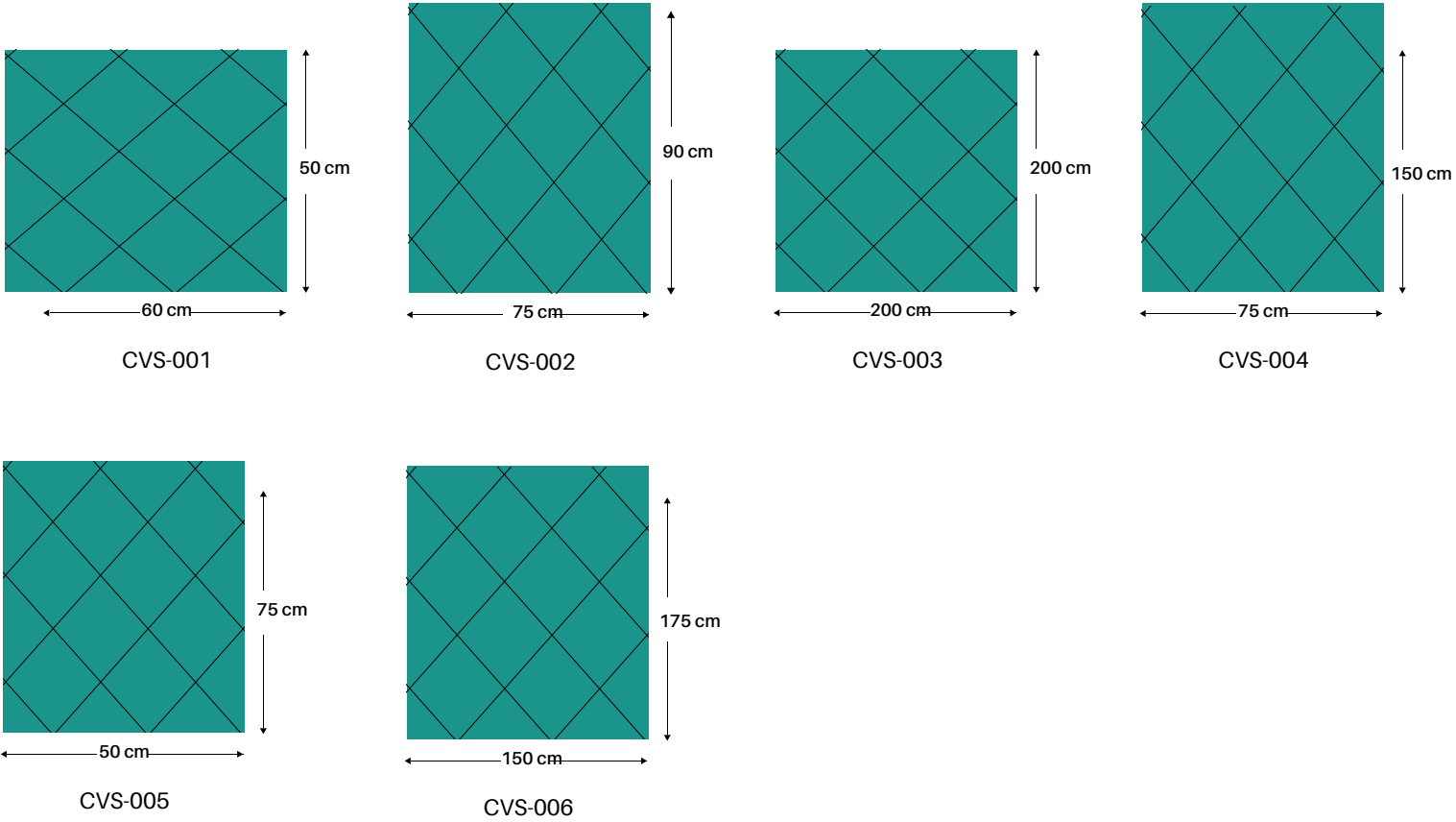

REF	DESCRIPTION
CVS-001	STERILE FOAM DRAPE 60 x 50 CM
CVS-002	STERILE FOAM DRAPE 75 X90 CM
CVS-003	STERILE FOAM DRAPE 200 X 200 CM
CVS-004	STERILE FOAM DRAPE 75 X 150 CM
CVS-005	STERILE FOAM DRAPE 50 X 75 CM
CVS-006	STERILE FOAM DRAPE 150 X 175 CM

Fabric Materials :

- SMS
- Adhesive
- SMS + PE Coated
- Absorbent Non-woven (Reinforcement)
- Transparent Sheet
- Viscose + PE

Adhesive Viscose Drapes

CVA-SMI

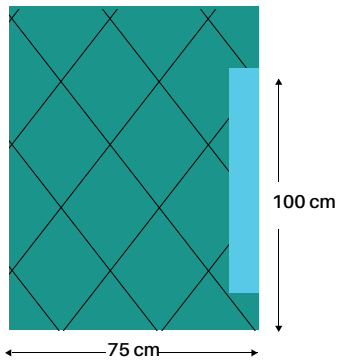

CVA-001

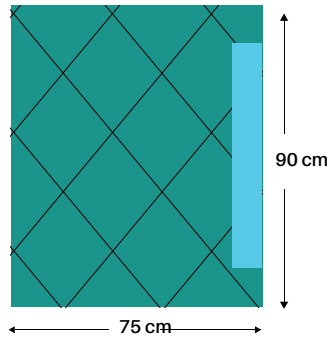

CVA-002

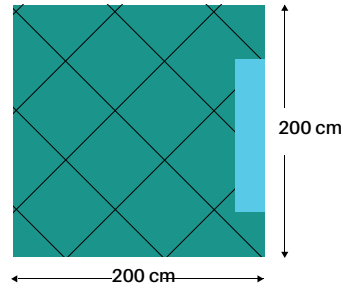

CVA-003

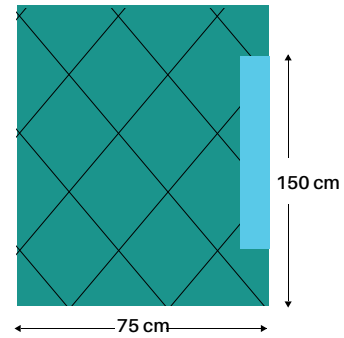

CVA-004

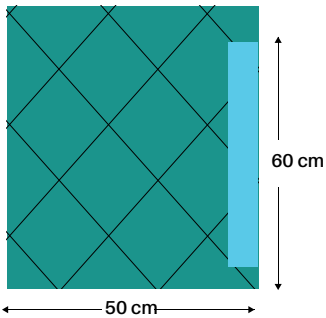

CVA-005

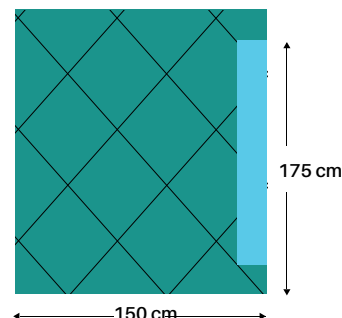

CVA-006

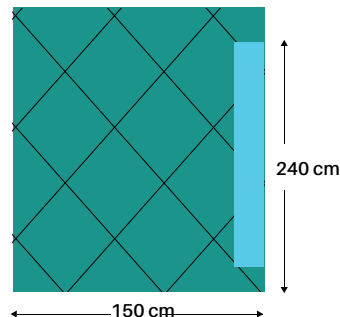

CVA-008

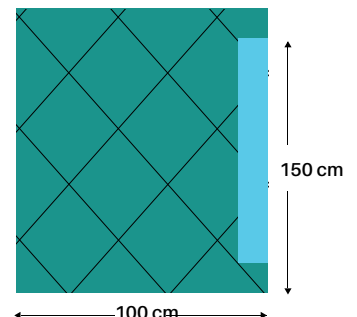

CVA-009

REF	DESCRIPTION
CVA-001	STERILE ADHESIVE FOAM DRAPE 75 x 100 CM
CVA-002	STERILE ADHESIVE FOAM DRAPE 75 X 90 CM
CVA-003	STERILE ADHESIVE FOAM DRAPE 200 X 200 CM
CVA-004	STERILE ADHESIVE FOAM DRAPE 75 X150 CM
CVA-005	STERILE ADHESIVE FOAM DRAPE 50 X 60 CM
CVA-006	STERILE ADHESIVE FOAM DRAPE 150 X 175 CM
CVA-008	STERILE ADHESIVE FOAM DRAPE 150 X 240 CM
CVA-009	STERILE ADHESIVE FOAM DRAPE 100 x 150 CM

Fabric Materials :

SMS Adhesive

SMS + PE Coated Absorbent Non-woven (Reinforcement)

Transparent Sheet Viscose + PE

Fenestrated Viscose Drape

CVS-SMI

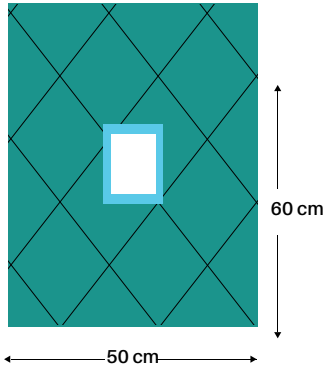

CVF-001

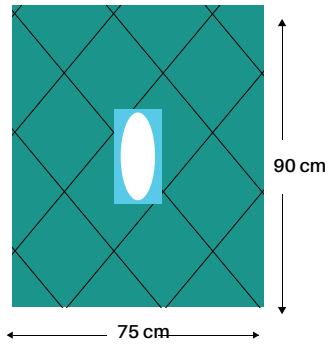

CVF-002

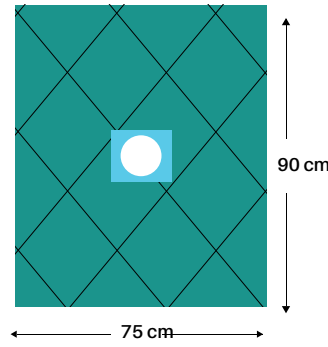

CVF-003

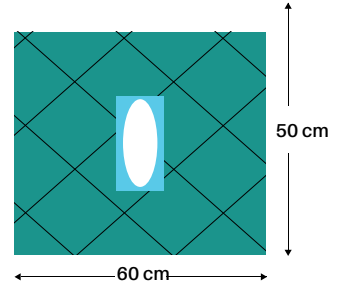

CVF-004

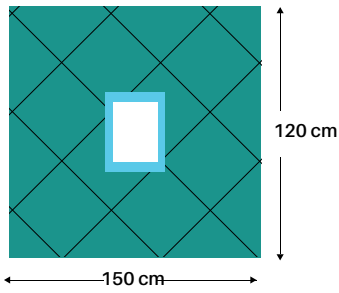

CVF-005

REF	DESCRIPTION
CVF-001	STERILE FENESTRATED DRAPE 60 X 50 CM
CVF-002	STERILE FENESTRATED DRAPE 75 X 90 CM
CVF-003	STERILE FENESTRATED FOAM DRAPE 75 X 90 CM
CVF-004	STERILE FENESTRATED FOAM DRAPE 60X50 CM
CVF-005	STERILE FENESTRATED FOAM DRAPE 150X120 CM

Fabric Materials :

SMS Adhesive

SMS + PE Coated Absorbent Non-woven (Reinforcement)

Transparent Sheet Viscose + PE





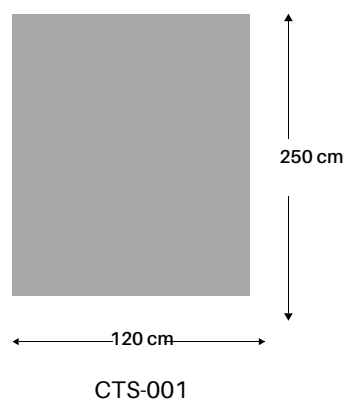

Standard Transparent Sheet

CTS-SMI



REF	DESCRIPTION
CTS-001	STERILE FLEXI DRAPE 120X250 CM

Fabric Materials :

 SMS	 Adhesive
 SMS + PE Coated	 Absorbent Non-woven Reinforcement
 Transparent Sheet	 Viscose + PE

Adhesive Transparent Sheet

CAT-SMI

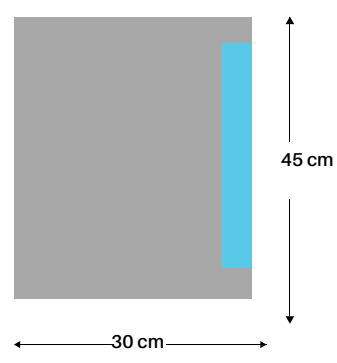

CAT-001

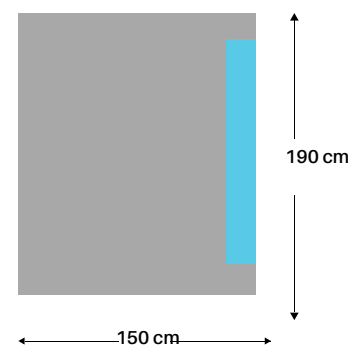

CAT-002

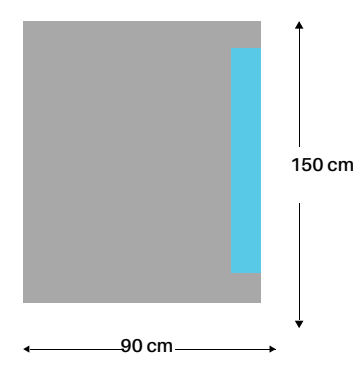

CAT-003

REF	DESCRIPTION
CTS-001	STERILE ADHESIVE FLEXI DRAPE 30X45CM
CTS-002	STERILE ADHESIVE FLEXI DRAPE 150X190CM
CTS-003	STERILE ADHESIVE FLEXI DRAPE 90X150CM

Fabric Materials :

- SMS
- Adhesive
- SMS + PE Coated
- Absorbent Non-woven (Reinforcement)
- Transparent Sheet
- Viscose + PE

Fenestrated Transparent Sheet

CFT-SMI

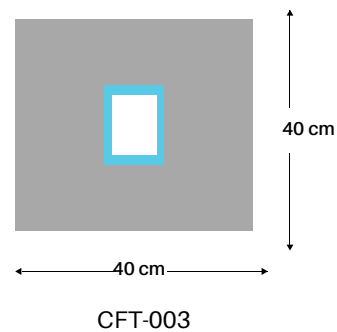
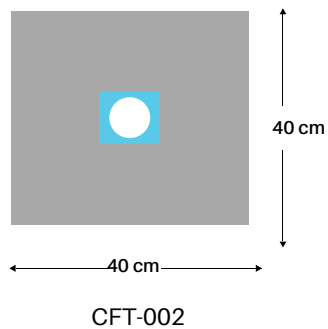
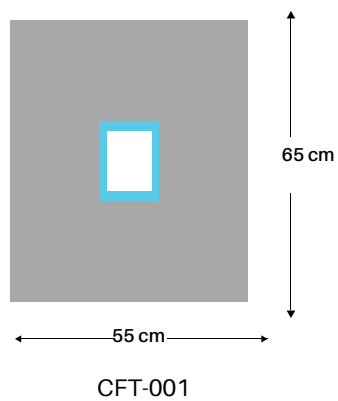

REF	DESCRIPTION
CFT-001	STERILE FENESTRATED FLEXI DRAPE 55 X 65 CM
CFT-002	STERILE FENESTRATED FLEXI DRAPE 40 X 40CM
CFT-003	STERILE FENESTRATED FLEXI DRAPE 40 X 40CM

Fabric Materials :

- SMS
- Adhesive
- SMS + PE Coated
- Absorbent Non-woven (Reinforcement)
- Transparent Sheet
- Viscose + PE

Sterile Reinforcement Sheet

CRC-SMI

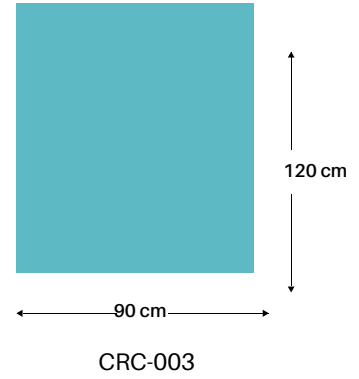
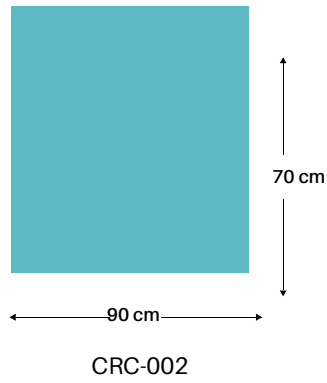
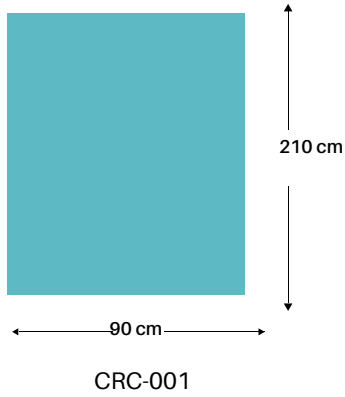

REF	DESCRIPTION
CRC-001	STERILE SURGICAL SHEET 90X210 CM
CRC-002	STERILE SURGICAL SHEET 90X70 CM
CRC-003	STERILE SURGICAL SHEET 90 x120 CM

Fabric Materials :

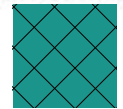

Sterile Fenestrated Reinforcement Sheet



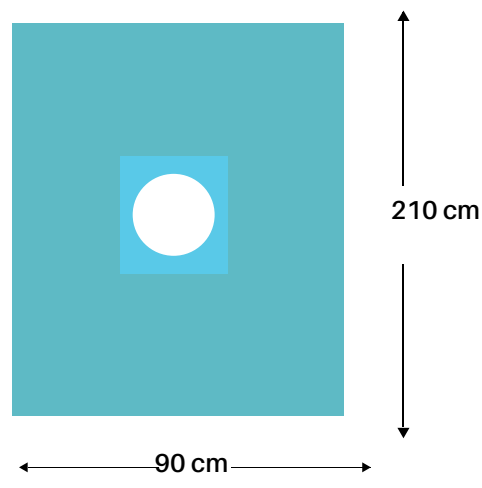



CRF-SMI



CRC-001

REF	DESCRIPTION
CRF-001	STERILE SURGICAL SHEET 90X210 CM

Fabric Materials :

 SMS	 Adhesive
 SMS + PE Coated	 Absorbent Non-woven (Reinforcement)
 Transparent Sheet	 Viscose + PE



Speciality Drapes

CPS-SMI

Neuro Split Drape

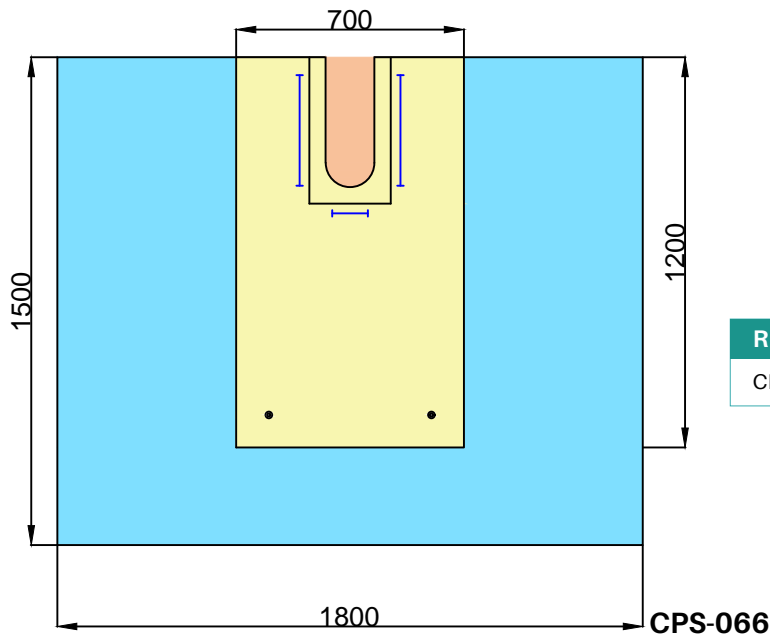

REF	DESCRIPTION
CPS-066	NUERO SPLIT DRAPE 150X180 CM

Angiographic Drape

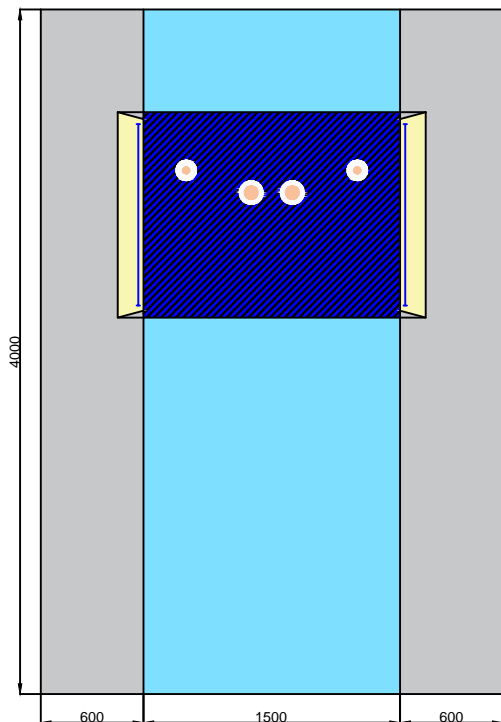

REF	DESCRIPTION
CPS-089	ANGIOGRAPHIC DRAPE
CPS-023	ANGIO 4 HOLE 210X360 CM

Extremity Drape

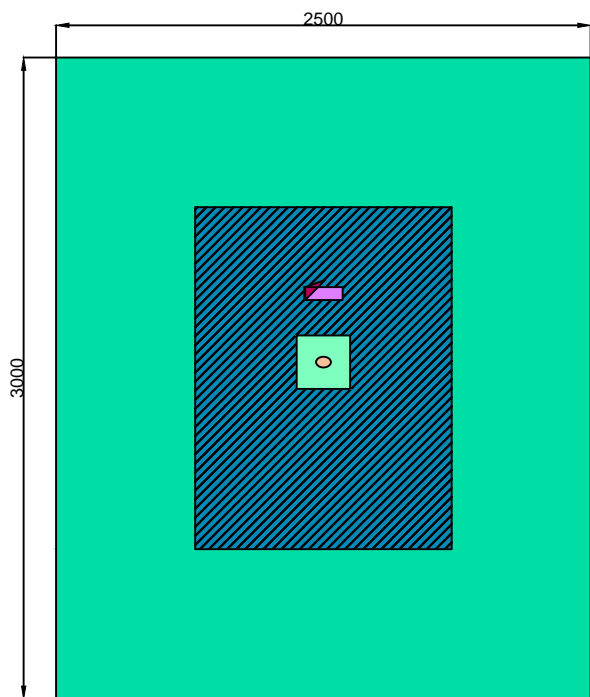

REF	DESCRIPTION
CPS-070	LOWER EXTREMITY DRAPE 300X250 CM
CPS-071	UPPER EXTREMITY DRAPE 300X250 CM

Craniotomy Drape

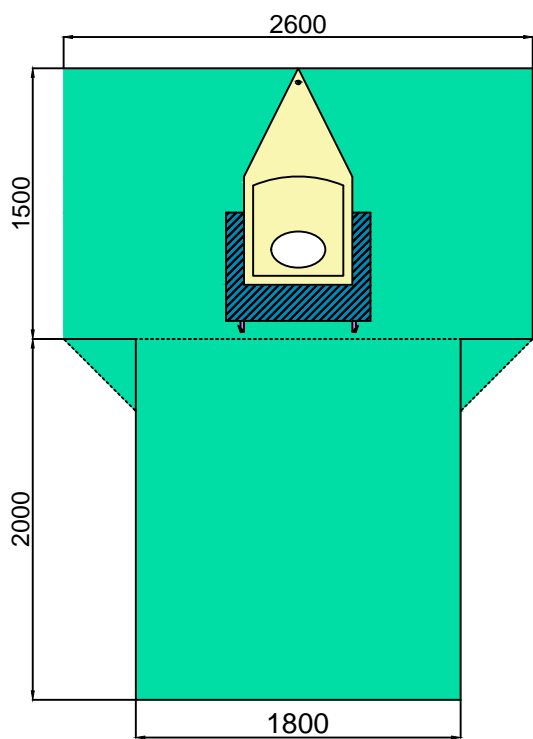

REF	DESCRIPTION
CPS-039	CRANIOTOMY DRAPE 180/230X310
CPS-035	CRANIOTOMY DRAPE 230X300
CPS-025	CRANIOTOMY DRAPE 200X400

ENT Split Drape

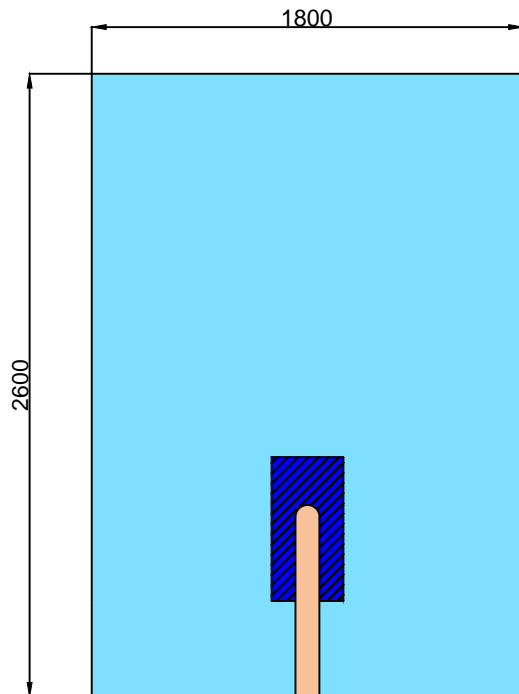

REF	DESCRIPTION
CPS-010	ENT SPLIT DRAPE 180X250 CM

U Split Drape

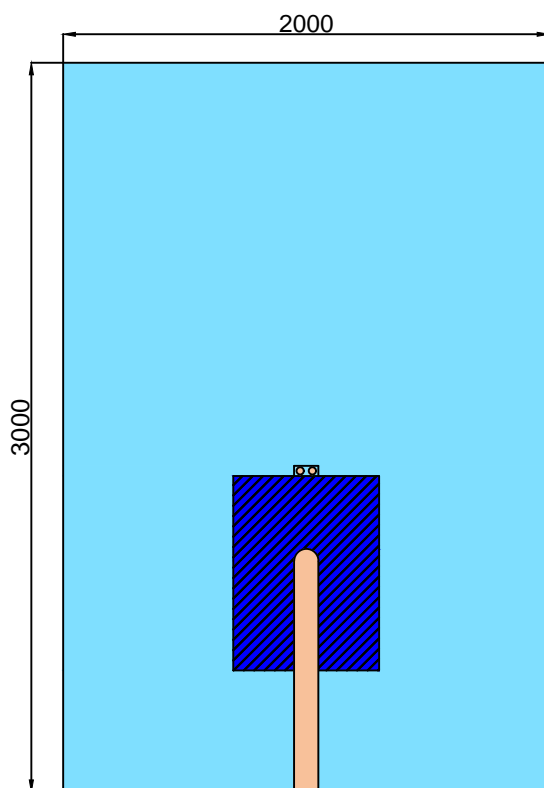

REF	DESCRIPTION
CPS-061	U SPLIT DRAPE



Ophthalmic Drape

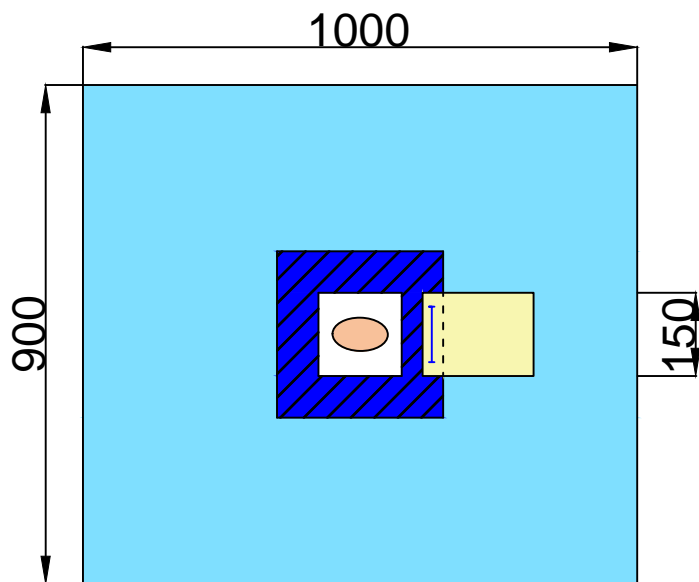

REF	DESCRIPTION
CPS-064	OPHTHALMIC DRAPE 100X65 CM

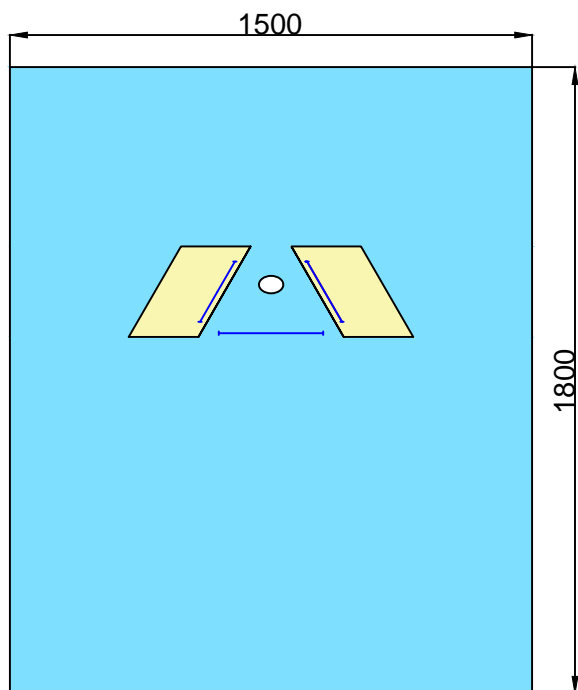

REF	DESCRIPTION
CPS-065	OPHTHALMIC DRAPE 150X130 CM

Ophthalmic Drape

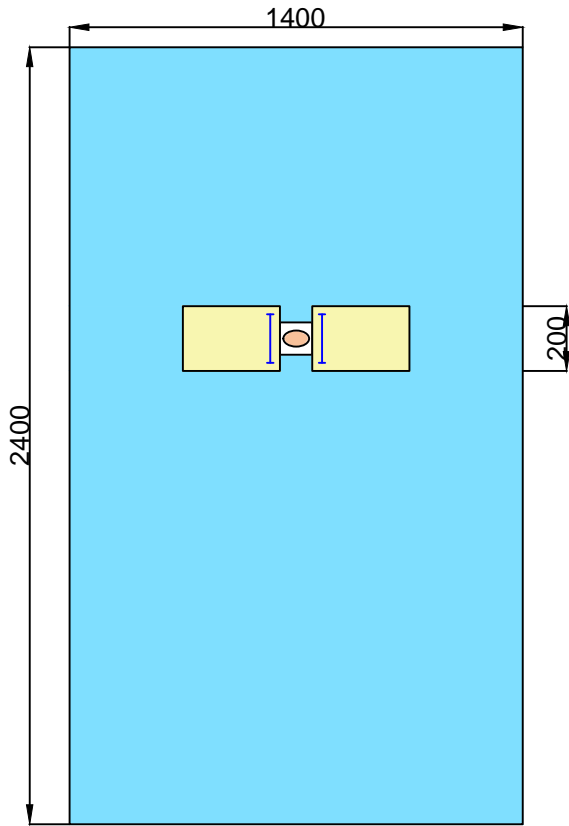

REF	DESCRIPTION
CPS-015	OPHTHALMIC DRAPE 150X240 CM

Thyroid Drape

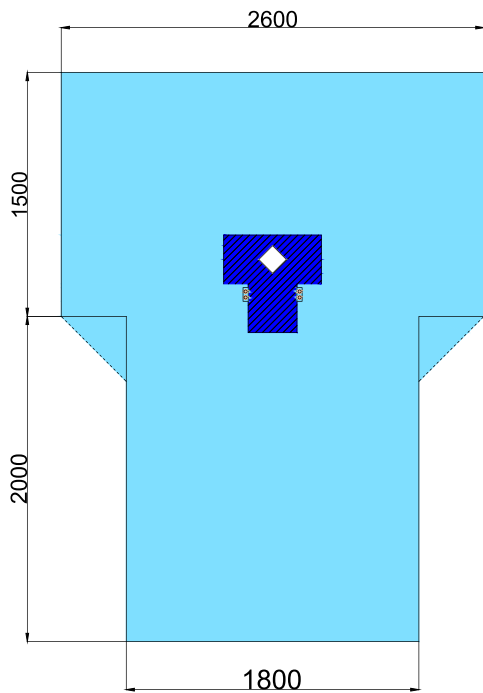

REF	DESCRIPTION
CPS-057	THYROID DRAPE 180/250X310 CM

Under Buttocks Drape

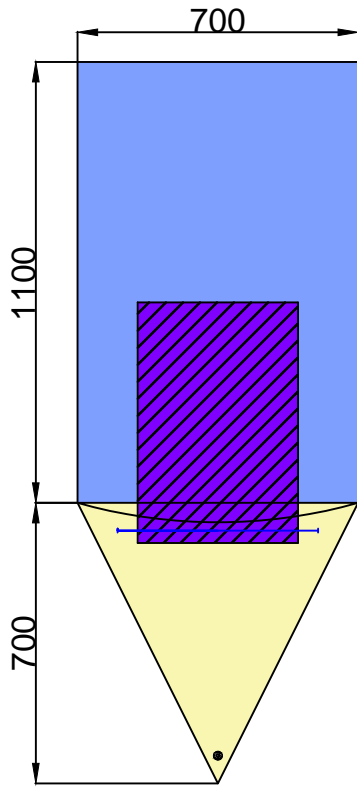

REF	DESCRIPTION
CPS-104	UNDER BUTTOCKS DRAPE 80X120 CM

Under Buttocks Drape

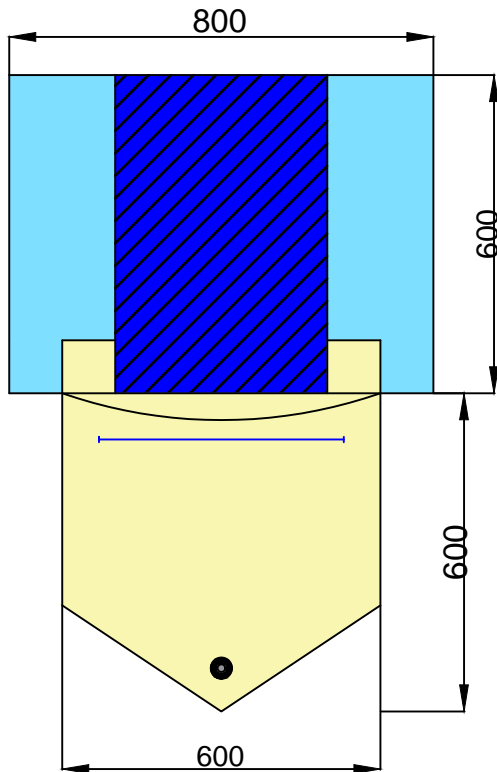

REF	DESCRIPTION
CPS-080	UNDER BUTTOCKS DRAPE 80X120 CM

Cardiovascular Drape

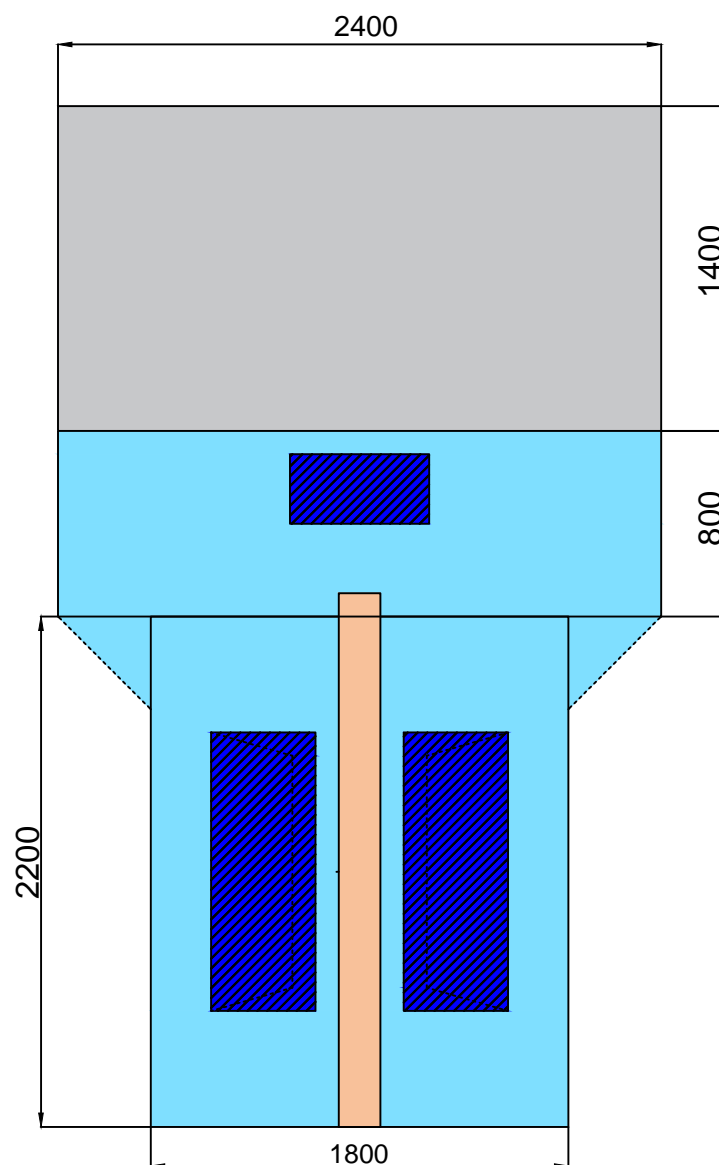

REF	DESCRIPTION
CPS-106	CARDIOVASCULAR DRAPE 200/280X360 CM



A close-up photograph showing a hand in a blue surgical glove being held by a bare hand. Another hand is visible below, resting on a white surface. The background is bright and slightly blurred.

Surgical Drapes

CDR-SDR

5%

Dental Drape Set



REF 57-001	
DESCRIPTION	QTY
STERILE FIELD	1
STERILE FENESTRATED DRAPE 80 X 80 WITH 12 X 14 FENESTRATION	1
STERILE ADHESIVE DRAPE 80 X60 (7CM LENGTH ADHESIVE ON TOP TWO SIDE)	1

Set Up Pack



REF 44-001	
DESCRIPTION	QTY
BACK TABLE COVER ZONAL REINFORCED 150 X 260	1
MAYO STAND COVER	1

Cystoscopy Set



REF 10-320

DESCRIPTION	QTY
ABSORBENT TOWELS	2
LITHOTOMY SHEET	1
STERILE FILED	1

REF 10-321

DESCRIPTION	QTY
BACK TABLE COVER 140 X 210	1
ABSORBENT TOWEL	2
LITHOTOMY DRAPE WITH LEGGINGS	1
SURGICAL GOWN L	2
MAYO STAND COVER	1
WRAP	1

REF 10-323

DESCRIPTION	QTY
BACK TABLE COVER REINFORCED 150 X 230	1
LEGGINGS WITH CUFF	2
ABSORBENT TOWEL	1
CYSTOSCOPY T DRAPE	1
STERILE FIELD	1

REF 10-323-01

DESCRIPTION	QTY
BACK TABLE COVER ZONAL REINFORCED 150 X 190	1
LEGGINGS WITH CUFF	2
ABSORBENT TOWEL	2
CYSTOSCOPY T DRAPE	1
STANDARD GOWN MEDIUM	1
MAYO STAND COVER	1
STERILE FIELD	1

REF 10-328

DESCRIPTION	QTY
ABSORBENT TOWELS	2
UNDER BUTTOCKS DRAPE	1
LITHOTOMY SHEET	1
LEGGINGS LARGE	2
STERILE FIELD	1

REF 10-325

DESCRIPTION	QTY
BACK TABLE COVER REINFORCED	1
LITHOTOMY LEGGINGS	2
APERATURE DRAPE	1
STERILE FIELD	1

REF 10-326

DESCRIPTION	QTY
BACK TABLE COVER REINFORCED	1
LITHOTOMY LEGGINGS	2
APERATURE DRAPE	1
HAND TOWEL	1
STERILE FIELD	1

REF 10-331

DESCRIPTION	QTY
BACK TABLE COVER REINFORCED 150 X 190	1
LEGGINGS WITH CUFF	2
HAND TOWEL	2
CYSTOSCOPY DRAPE 150 X 200	1
STERILE FIELD	1

REF 10-331-01

DESCRIPTION	QTY
BACK TABLE COVER REINFORCED 150 X 190	1
LEGGINGS WITH CUFF	2
HAND TOWEL	2
CYSTOSCOPY DRAPE WITH POUCH 150 X 200	1
STERILE FIELD	1

REF 10-333

DESCRIPTION	QTY
BACK TABLE COVER REINFORCED 150 X 190	1
LEGGINGS WITH CUFF	2
HAND TOWEL	2
U DRAPE 150 X 220 WITH 10 X 75 SPLIT AND REINFORCEMENT	1
STERILE FIELD	1

5%

C Section Pack



REF 10-316	
DESCRIPTION	QTY
GOWN (M)	2
GOWN (L)	1
MAYO STAND COVER	1
DISPOSABLE BAG	1
DRAPE C SECTION W/360*POUCH	1
SPONGE (LAP GAUZE) 45 X 45	10
SUCTION SET (YANKER, POOL&TTUBE)	1
BABY BLANKET	1
RECIEVER	1
NEEDLE COUNTER	1
BACK TABLE COVER	1

REF 10-317	
DESCRIPTION	QTY
GOWN XL	1
GOWN L	1
SUCTION CONNECTION TUBE	2
GAUZE 10 X10 (N/W)	15
LAP SPONGE 30 X30	5
SCALPEL 10	1
SCALPEL 20	1
CAUTERY PENCIL	1
SUTURES VICRYL	1
DRESSING (SAFEDRESS10 X7)	1
MESORB(MATERNITY PAD)	1
BULB SYRINGE (BABY MUCOUS ASPIRATOR)	1
C- SECTION DRAPE (SPONGE)	1
BACK TABLE COVER ZONAL REINFORCED 140 X 210	1
STERILE FIELD	1

REF 10-317-01	
DESCRIPTION	QTY
BACK TABLE COVER 150 X 190	1
REINFORCED GOWN L INSIDE WRAPPER WITH TOWEL	2
BULB SYRINGE	1
SURGICAL GOWN L	1
HAND TOWEL	2
C-SECTION DRAPE (SPONGE)	1
MAYO STAND COVER	1
BABY BLANKET	1
STERILE FIELD	1

REF 10-318	
DESCRIPTION	QTY
GOWN (M)	2
GOWN (L)	2
PREP TRAY WITH3 PCS PREP SPONG STICK	1
GAUZE 20 X20	10
LAP SPONGE 30 X 30	15
BLADE NO.21	2
CAUTERY PEN	1
SURGICAL BLUE TOWEL (OR TOWEL)	2
SUCTION TUBE	1
YANKAUER	1
COSMOPORE	4
TEGADERM 1626W	1
PLAIN GAUZE	1
DIATHERMY BAG	1
C SECTION DRAPE (TRIANGLE FEN NEW ONE WITH AKSHAY)	1
NEEDLE COUNTER (20 CNT)	1
SHARP TRANSFER TRAY	1
UTILITY DRAPE	4
BACK TABLE COVER	1

REF 10-319	
DESCRIPTION	QTY
BACK TABLE COVER REINFORCED 150 X 190	1
REINFORCED GOWN L	2
BULB SYRRINGE	1
CORD CLAMP	1
STERILE FIELD	1
YANKUAER SUCTION TIP	1
SUCTION TUBE	1
SUTURE BAG	1
HAND TOWEL	4
MAYO STAND COVER	1
BABY BLANKET	1
C-SECTION DRFAPE (SPONGE)	1
GAUZE 10 X 10 XRAY	15

REF 10-315	
DESCRIPTION	QTY
BACK TABLE COVER 150 X 190	1
MAYO STAND COVER	1
CELLULOSE TOWEL	4
OP TAPE	1
BABY BLANKET	1
C SECTION DRAPE (SPONGE)	1
STERILE FIELD	1

REF 10-315	
DESCRIPTION	QTY
BACK TABLE COVER 150 X 190	
MAYO STAND COVER	4
CELLULOSE TOWEL	1
OP TAPE	1
BABY BLANKET	1
C SECTION DRAPE(SPONGE)	1
YANKAUER HANDLE	1
STERILE FIELD	1
SUCTION CONNECTION TUBE	1
STERILE FIELD	1

REF 10-318-01	
DESCRIPTION	QTY
BACK TABLE COVER 150 X 190	1
HAND TOWEL	8
GOWN LARGE	3
MAYO STAND COVER	1
SCALPEL 10	1
SCALPEL 20	1
SUTURE BAG	1
BULB SYRINGE	1
NEEDLE COUNTER 10 CNT	1
CORD CLAMP	1
CAUTERY PENCIL	1
SYRINGE 20 ML L\L	1
LAP SPONGE 30 X 30	10
GAUZE 10 X20 XRAY	10
MATERNITY PAD	1
SHARP TRANSFER TRAY	1
SUCTION CONNECTION TUBE	1
YANKAUER HANDLE	1
OP DRESSING (SAFEDRESS 9 X25)	1
SUCTION AND DIATHERMY BAG 20 X35	1
C-SECTION DRAPE (SPONGE)	1
BABY BLANKET	1
CREPE PAPER	2

REF 10-319	
DESCRIPTION	QTY
BACK TABLE COVER REINFORCED 150 X 190	1
REINFORCED GOWN L	2
BULB SYRRINGE	1
CORD CLAMP	1
STERILE FIELD	1
YANKUAER SUCTION TIP	1
SUCTION TUBE	1
SUTURE BAG	1
HAND TOWEL	4
MAYO STAND COVER	1
BABY BLANKET	1
C-SECTION DRFAPE (SPONGE)	1
GAUZE 10 X 10 XRAY	15

5%

REF 10-319-01	DESCRIPTION	QTY
	BACK TABLE COVER	1
	REINFORCED 150 X 190	
	REINFORCED GOWN L	1
	STANDARD GOWN L	1
	BULB SYRRINGE	1
	CORD CLAMP	1
	GAUZE 10 X 10 XRAY	10
	YANKUAER SUCTION TIP	1
	SUCTION TUBE 10FT	1
	SUTURE BAG	1
	OR TOWEL	2
	HAND TOWEL	4
	MAYO STAND COVER	1
	BABY BLANKET	1
	C-SECTION DRFAPE (SPONGE)	1
	STERILE FIELD	1

REF 10-319-03	DESCRIPTION	QTY
	BACK TABLE COVER	1
	REINFORCED 150 X190	
	MAYO STAND COVER	1
	SUTURE BAG	1
	C-SECTION DRFAPE (BAND)	1
	BABY BLANKET	1
	HAND TOWEL	3
	GAUZE 10 X 10 XRAY	10
	BULB SYRRINGE	1
	CORD CLAMP	1
	YANKUAER SUCTION TIP	1
	SUCTION TUBE 10 FT	1
	STERILE FIELD	1

REF 31-002	DESCRIPTION	QTY
	BACK TABLE COVER	1
	REINFORCED 150 X190	
	MAYO STAND COVER	1
	HAND TOWEL	4
	CORD CLAMP	2
	BABY BLANKET	1
	C-SECTION DRAPE(BAND)	1
	STERILE FIELD	1

REF 31-004	DESCRIPTION	QTY
	BACK TABLE COVER REINFORCED 150 X 190	1
	BABY BLANKET	1
	C-SECTION DRAPE	1
	LID FOR PLACENTA BASIN	1
	OP TAPE	1
	SCALPEL NO 10	1
	PLACENTA TRAY	1
	SCALPEL NO 20	1
	FLUID COLLECTION POUCH (40 X 35)	1
	SUCTION TUBE 3.6M	1
	YANKAUER HANDLE	1
	KIDNEY DISH 700 ML (TRANSPARENT)	1
	INSTRUMENT CLEANER	1
	CAUTERY PENCIL	1
	SKIN CLOSURE STRIP 12MM X 100MM	2
	SYRINGE 10 ML L/L (H D)	2
	NEEDLE COUNTER 20 COUNT FM+MG	1
	GAUZE 10 X10 XRAY	10
	GAUZE ROUND	5
	LAP SPONGE 45 X45 XRAY	10
	SANITARY PAD	1
	JUG 1200ML	1
	BOWL 1000ML	1
	MAYO STAND COVER	1
	SURGICAL GOWN XL	2
	SURGICAL GOWN L	1
	HAND TOWEL	6
	STERILE FIELD	1

REF 31-006	DESCRIPTION	QTY
	BACK TABLE COVER REINFORCED 150 X 190	1
	SURGICAL GOWN L	1
	SURGICAL REINFORCED GOWN L	1
	HAND TOWEL	4
	GAUZE 10 X 10 XRAY	10
	BULB SYRINGE	0
	CORD CLAMP	1
	YANKAUER HANDLE	1
	SUCTION TUBE 3.6M	1
	SUTURE BAG	1
	BABY BLANKET	1
	OR TOWEL	1
	MAYO STAND COVER	2
	C SECTION DRAPE (SPONGE)	1
	LAP SPONGE 30 X 30 (5 PACK)	1
	GAUZE 10 X 10 N/W	2
	GOWN REINFORCED XL	1
	STERILE FIELD	

REF 31-005	DESCRIPTION	QTY
	BACK TABLE COVER REINFORCED 150 X 190	1
	HAND TOWEL	2
	SURGICAL GOWN LARGE WITH 2 HAND	1
	TOWELS WRAPPED	
	REINFORCED GOWN L	2
	MAYO STAND COVER	1
	SUTURE BAG	1
	GAUZE 10 X 10 XRAY	10
	LAP SPONGE 30 X 30 XRAY	10
	YANKAUER HANDLE	1
	BLADE NO.21	2
	SUCTION AND DIATHERMY BAG 20 X35	1
	MATERNITY PAD	1
	SUCTION TUBE 3.6M	1
	CORD CLAMP	1
	BULB SYRINGE	1
	SYRINGE 10 ML L/L	1
	ADHERENT DRESSING (SAFE DRESS 10 X 25)	1
	C- SECTION DRAPE (BAND)	1
	NEEDLE COUNTER 20 COUNT FM +MG	1
	SHARP TRANSFER TRAY	1
	STERILE FIELD	1

REF 31-007	DESCRIPTION	QTY
	BACK TABLE COVER REINFORCED 150 X 190	1
	C SECTION DRAPE (BAND)	1
	BABY BLANKET	1
	PLACENTA BASIN 2500ML	1
	CORD CLAMP	1
	BULB SYRINGE	1
	SUTURE BAG	1
	MATEERNITY PAD	1
	STERILE FIELD	1

REF 31-008	DESCRIPTION	QTY
	BACK TABLE COVER ZONAL	1
	REINFORCED 150 X 190	
	MAYO STAND COVER	1
	C SECTION DRAPE (BAND)	1
	BABY BLANKET	1
	HAND TOWEL	2
	SUTURE BAG	1
	REINFORCED GOWN LARGE	1
	STERILE FIELD	1

REF 31-009	DESCRIPTION	QTY
	BACK TABLE COVER ZONAL	1
	REINFORCED 150 X 190	
	C SECTION DRAPE WITH BAND 180/250 X 300	1
	BABY BALNKET	1
	HAND TOWEL	1

REF 31-011	DESCRIPTION	QTY
	BACK TABLE COVER REINFORCED 150 X 190	1
	HAND TOWEL	2
	SURGICAL GOWN LARGE	1
	GAUZE 10 X 10 XRD	10
	BULB SYRINGR	1
	CORD CLAMP	1
	YANKAUER HANDLE	1
	SUCTION TUBE 3.6M	1
	SUTURE BAG	1
	BABY BLANKET	1
	OR TOWEL	2
	MAYO STAND COVER	1
	C SECTION DRAPE SPONGE (MP)	1
	STERILE FIELD	1

REF 31-011	DESCRIPTION	QTY
	BACK TABLE COVER ZONAL	1
	REINFORCED 150 X 190	
	MAYO STAND COVER	1
	CELLULOSE TOWEL	4
	OP TAPE	1
	BABY BLANKET	1
	C SECTION DRAPE (SM + PE) SAFECARE	1

5%

Lithotomy Pack



REF 27-001-01	
DESCRIPTION	QTY
BACK TABLE COVER REINFORCED 110 X 180	1
LEGGINGS 75 X 120	2
UTILITY DRAPE 60 X45 WITH TAPE	1
HALF DRAPE REINFORCED 110 X150	1
HAND TOWEL	1
UNDER BUTTOCKS DRAPE WITH POUCH	1
STERILE FIELD	1

REF 27-002	
DESCRIPTION	QTY
ABSORBENT TOWEL	1
LEGGINGS	2
LITHOTOMY T DRAPE	1

REF 27-003	
DESCRIPTION	QTY
BACK TABLE COVER REINFORCED	1
ABSORBENT TOWEL	1
LITHOTOMY DRAPE WITH ATTACHED LEGGINGS	1

REF 27-004	
DESCRIPTION	QTY
BACK TABLE COVER REINFORCED 150X 190	1
SURGICAL GOWN (L)	1
ABSORBENT TOWEL	2
LEGGINGS	2
GAUZE SWAB 10X10 CM XRAY	10
UTILITY DRAPE 26"X 15" WITH ADHESIVE	1
UNDER BUTTOCKS DRAPE WITH POUCH	1
MATERNITY PAD	1
LITHO T DRAPE	1

REF 27-006	
DESCRIPTION	QTY
BACK TABLE COVER REINFORCED 150X 190	1
SURGICAL GOWN (L)	1
ABSORBENT TOWEL	2
LEGGINGS	2
GAUZE SWAB 10X10 CM XRAY	10
UNDER BUTTOCKS DRAPE WITH POUCH (SAFECARE)	1
MATERNITY PAD	1
ADHESIVE DRAPE 90 X 80	1

REF 27-007	
DESCRIPTION	QTY
BACK TABLE COVER REINFORCED 150 X 180	1
ABSORBENT TOWEL (OR TOWEL)	1
LEGGINGS 75 X 120	2
UTILITY DRAPE 60 X45 WITH TAPE	1
HALF DRAPE REINFORCED 110 X150	1
HAND TOWEL	1
UNDER BUTTOCKS DRAPE WITHOUT POUCH (MAYO)	1
STERILE FIELD	1

REF 27-008	
DESCRIPTION	QTY
BACK TABLE COVER REINFORCED 110 X 180	1
HAND TOWEL	1
ADHESIVE DRAPE 60 X 45	1
UNDER BUTTOCKS WITH POUCH(MP)	1
LEGGINGS	2
HALF DRAPE 110 X150 (NORMAL)	1
STERILE FIELD	1

REF 27-009	
DESCRIPTION	QTY
BACK TABLE COVER REINFORCED 110 X 180	1
LITHOTOMY DRAPE WITH ATTACHED LEGGINGS SAFECARE	1
STERILE FIELD	1

REF 27-009-01	
DESCRIPTION	QTY
BACK TABLE COVER REINFORCED 110 X 180	1
MAYO STAND COVER	1
HAND TOWEL	1
STERILE FIELD	1

REF 27-010	
DESCRIPTION	QTY
BACK TABLE COVER REINFORCED 150X 190	1
HAND TOWEL	2
MAYO STAND COVER	1
OP TAPE	1
REINFORCED SIDE DRAPE 75 X 90	1
LITHOTOMY T DRAPE	1
STERILE FIELD	1

REF 27-010-01	
DESCRIPTION	QTY
BACK TABLE COVER REINFORCED 150X 190	1
HAND TOWEL	2
MAYO STAND COVER	1
OP TAPE	1
REINFORCED SIDE DRAPE 75 X 90	1
LITHOTOMY T DRAPE	1
LEGGINGS	2
STERILE FIELD	1

REF 27-011	
DESCRIPTION	QTY
BACK TABLE COVER REINFORCED 150X 190	1
LEGGINGS 75 X 120	2
REINFORCED DRAPE 90 X150	1
REINFORCED DRAPE 75 X 50	1
REINFORCED DRAPE 75 X 100	1
UNDER BUTTOCKS DRAPE	1
ADHESIVE DRAPE 170 X170	1
KIDNEY DISH 700 ML (GOLD)	1
TWO WAY 14 FR	1
STERILE FIELD	1

REF 27-012	
DESCRIPTION	QTY
BACK TABLE COVER REINFORCED 150X 190	1
HAND TOWEL	2
MAYO STAND COVER	1
OP TAPE	1
ADHESIVE SIDE DRAPE REINFORCED 75X90	1
LITHOTOMY DRAPE	1
STERILE FILED	1

5%

Gynaecology Pack



REF 10-308	
DESCRIPTION	QTY
ABSORBENT TOWEL	2
UNDER BUTTOCK	1
LEGGINGS	2
LITHOTOMY DRAPE 15X15X15 TRIANGLE	1
FENESTRATION WITH POUCH SUCTION PORT	
NEEDLE COUNTER	1
TABLE COVER REINFORCED	1
UTILITY BAG	1
UPPER DRAPE 180X180CM	1
LARGE TOWELS	2
MEDIUM TOWELS	2
DIATHERMY PACK	1
STERILE FIELD	1

REF 10-309	
DESCRIPTION	QTY
BACK TABLE COVER REINFORCED 150 X 190	1
SET UP DRAPE 120 X 120	1
LEGGINGS	3
UNDER BUTTOCKS DRAPE WITH POUCH	1
ABDOMINAL DRAPE REINFORCED 120 X150	1
HAND TOWEL	4
STERILE FIELD	1

REF 10-309-01	
DESCRIPTION	QTY
BACK TABLE COVER REINFORCED 150 X 190	1
SET UP DRAPE 100 X 190	1
LEGGINGS	3
UNDER BUTTOCKS DRAPE WITH POUCH	1
ABDOMINAL DRAPE REINFORCED 120 X150	1
HAND TOWEL	4
STERILE FIELD	1

REF 10-310	
DESCRIPTION	QTY
BACK TABLE COVER REINFORCED 150 X 190	1
GYNAECOLOGY DRAPE SAFECARE 75 X200	1
LEGGINGS	2
HAND TOWEL	2
SURGICAL GOWN LARGE	1
DRAPE 75 X 90	1
STERILE FIELD	1

REF 10-307	
DESCRIPTION	QTY
ABSORBENT TOWEL	2
UNDER BUTTOCK	1
LEGGINGS	2
LITHOTOMY DRAPE 15X15X15 TRIANGLE	1
FENESTRATION WITH POUCH SUCTION PORT	
NEEDLE COUNTER	1
TABLE COVER REINFORCED	1
UTILITY BAG	1
UPPER DRAPE 180X180CM	1
STERILE FIELD	1

REF 10-310-01	
DESCRIPTION	QTY
BACK TABLE COVER REINFORCED 150 X 190	1
GYNAECOLOGY DRAPE SAFECARE 75 X 150	1
LEGGINGS	2
HAND TOWEL	2
75 X 90 NORMAL DRAPE	1
STERILE FIELD	1

REF 10-311	
DESCRIPTION	QTY
BACK TABLE COVER REINFORCED 150 X 190	1
GYNAECOLOGY DRAPE SAFECARE WITH POUCH (SM+PE)	1
HAND TOWEL	2
ADHESIVE DRAPE (TRANSPARENT FILM) 50 X 50	1
OP TAPE	1
MAYO STAND COVER	1
STERILE FIELD	1

REF 10-311-01	
DESCRIPTION	QTY
BACK TABLE COVER ZONAL REINFORCED 150 X 190	1
GYNAECOLOGY DRAPE SAFECARE WITHOUT POUCH (SM+PE)	1
HAND TOWEL	2
ADHESIVE DRAPE (TRANSPARENT FILM) 50 X 50	1
OP TAPE	1
MAYO STAND COVER	1
STERILE FIELD	1

REF 10-312	
DESCRIPTION	QTY
BACK TABLE COVER REINFORCED 150 X190	1
LEGGINGS	2
UNDER BUTTOCKS DRAPE WITH POUCH	1
HAND TOWEL	2
ABDOMINAL DRAPE REINFORCED100 X150	1
STERILE FIELD	1

REF 10-330	
DESCRIPTION	QTY
BACK TABLE COVER- 150*160	1
TOWEL	2
UNDERBUTTOCKS DRAPE - 80*110	1
LEG COVER - 70*120	2
ABDOMINAL DRAPE - 100*150	1
BACK TABLE COVER - 150*190	1
REINFORCED GOWN L	1
BABY TRAY	1
WRAP	1

REF 28-001	
DESCRIPTION	QTY
BACK TABLE COVER- 112*160	1
TOWEL	2
UNDERBUTTOCKS DRAPE - 80*110	1
LEG COVER - 70*120	2
ABDOMINAL DRAPE - 100*150	1
SET UP COVER - 110 X 190	1

REF 28-002	
DESCRIPTION	QTY
BACK TABLE COVER- 112*160	1
TOWEL	2
UNDERBUTTOCKS DRAPE - 80*110	1
LEG COVER - 70*120	2
ABDOMINAL DRAPE - 100*150	1
SET UP COVER - 110 X 190	1

5%

Universal Pack



REF 1102	
DESCRIPTION	QTY
BACK TABLE COVER REINFORCED 150X190CM	1
MAYO STAND COVER 75X145CM	1
ADHESIVE TOP DRAPE REINFORCED 150X240CM	1
ADHESIVE BOTTOM DRAPE REINFORCED 160X190CM	1
ADHESIVE SIDE DRAPE 75X90CM	2
ADHESIVE TAPE STRIP 8X50CM	1
HAND TOWEL	4

REF 1103	
DESCRIPTION	QTY
BACK TABLE COVER REINFORCED 150X190CM	1
SURGICAL GOWN REINFORCED	1
MAYO STAND COVER 80X145CM	1
ADHESIVE TOP DRAPE REINFORCED 150X240CM	1
ADHESIVE BOTTOM DRAPE REINFORCED 160X190CM	1
ADHESIVE SIDE DRAPE 75X90CM	2
ADHESIVE TAPE STRIP 8X50CM	1
HAND TOWEL 30X35CM	4

REF 1102-01	
DESCRIPTION	QTY
BACK TABLE COVER REINFORCED 150X190CM	1
MAYO STAND COVER 75X145CM	1
ADHESIVE TOP DRAPE REINFORCED 150X240CM	1
ADHESIVE BOTTOM DRAPE REINFORCED 170X190CM	1
ADHESIVE SIDE DRAPE REINFORCED 75X90CM	1
ADHESIVE TAPE STRIP 8X50CM	2
HAND TOWEL	1
SUTURE BAG	4

REF 1102-06	
DESCRIPTION	QTY
BACK TABLE COVER REINFORCED 150X190CM	1
MAYO STAND COVER 80X145CM	1
ADHESIVE TOP DRAPE REINFORCED 150X240CM	1
ADHESIVE BOTTOM DRAPE REINFORCED 170X190CM	1
ADHESIVE SIDE DRAPE REINFORCED 100 X 110CM	2
ADHESIVE TAPE STRIP 8X50CM	1
HAND TOWEL	4
INSTRUMENT POUCH (6" X 9")	1
STERILE FIELD	1

REF 1102-03	
DESCRIPTION	QTY
BACK TABLE COVER REINFORCED 150X190CM	1
MAYO STAND COVER 75X145CM	1
ADHESIVE TOP DRAPE 150X240CM	1
ADHESIVE BOTTOM DRAPE 150X190CM	1
ADHESIVE SIDE DRAPE 75X90CM	2
ADHESIVE TAPE STRIP 8X50CM	1
HAND TOWEL	4
STERILE FIELD	1

REF 1102-07	
DESCRIPTION	QTY
BACK TABLE COVER REINFORCED 150X190CM	1
ADHESIVE TOP DRAPE REINFORCED 150X240CM	1
ADHESIVE BOTTOM DRAPE REINFORCED 170X190CM	1
ADHESIVE SIDE DRAPE REINFORCED 190 X 100CM	2
ADHESIVE TAPE STRIP 8X50CM	1
HAND TOWEL	4
MAYO STAND COVER 75X145CM	1
STERILE FIELD	1

REF 1102-04	
DESCRIPTION	QTY
BACK TABLE COVER REINFORCED 150X190CM	1
MAYO STAND COVER 75X145CM	1
ADHESIVE TOP DRAPE REINFORCED 150X240CM	1
ADHESIVE BOTTOM DRAPE REINFORCED 150X190CM	1
ADHESIVE SIDE DRAPE REINFORCED 75X90CM	2
ADHESIVE TAPE STRIP 8X50CM	1
HAND TOWEL	4
STERILE FIELD	1

REF 1102-08	
DESCRIPTION	QTY
BACK TABLE COVER REINFORCED 150X190CM	1
HAND TOWEL	2
SURGICAL GOWN REINFORCED LARGE	1
SURGICAL GOWN REINFORCED X-LARGE	1
MAYO STAND COVER 75X145CM	1
NEEDLE COUNTER 20 COUNT FM + MG	1
ADHESIVE TAPE STRIP 8X50CM	2
SUTURE BAG	1
ADHESIVE DRAPE 50 X 75	4
ADHESIVE DRAPE 100 X 120	2
ADHESIVE TOP DRAPE REINFORCED 120 X150	2
ADHESIVE BOTTOM DRAPE REINFORCED 120 X170	1
ADHESIVE SIDE DRAPE REINFORCED 80 X 120	1
STERILE FIELD	1

REF 1102-05	
DESCRIPTION	QTY
BACK TABLE COVER REINFORCED 150X190CM	1
MAYO STAND COVER 75X145CM	1
ADHESIVE TOP DRAPE REINFORCED 150X240CM	1
ADHESIVE BOTTOM DRAPE REINFORCED 170X190CM	1
ADHESIVE SIDE DRAPE REINFORCED 100 X 110CM	2
ADHESIVE TAPE STRIP 8X50CM	1
HAND TOWEL	4
SUTURE BAG	1
STERILE FIELD	1

5%

Universal Pack



REF 1102-09	
DESCRIPTION	QTY
BACK TABLE COVER ZONAL REINFORCED 150X210CM	1
ADHESIVE TOP DRAPE REINFORCED WITH TUBE HOLDER 175 X 175	1
ADHESIVE BOTTOM DRAPE REINFORCED WITH TUBE HOLDER 150 X 240	1
ADHESIVE SIDE DRAPE REINFORCED 75 X 75	1
SUTURE BAG	1
OP TAPE	1
MAYO STAND COVER	1
HAND TOWEL	4
SUCTION AND DIATHERMY BAG 35 X 40	1
KIDNEY DISH 700 ML GOLD	1
NEEDLE COUNTER 20 CNT FM + MG	1
STERILE FIELD	1

REF 1120	
DESCRIPTION	QTY
BACK TABLE COVER ZONAL REINFORCED ADHESIVE TOP DRAPE REINFORCED 150X240CM (VISCOUS)	1
ADHESIVE BOTTOM DRAPE REINFORCED 170X170CM (VISCOUS)	1
ADHESIVE SIDE DRAPE REINFORCED 75 X 90CM (VISCOUS)	2
SUTURE BAG	1
MAYO STAND COVER 75X145CM	1
HAND TOWEL	4
OP TAPE	2

REF 1130	
DESCRIPTION	QTY
BACK TABLE COVER ZONAL REINFORCED ADHESIVE TOP DRAPE REINFORCED 150X240CM (PE + SM)	1
ADHESIVE BOTTOM DRAPE REINFORCED 170X190CM (PE + SM)	1
ADHESIVE SIDE DRAPE REINFORCED 75 X 90CM (PE + SM)	2
MAYO STAND COVER 75X145CM	1
HAND TOWEL	4
OP TAPE	1

REF 1102-10	
DESCRIPTION	QTY
BACK TABLE COVER ZONAL REINFORCED	1
MAYO STAND COVER	1
SIDE DRAPE REINFORCED 100 X 120	2
TOP DRAPE REINFORCED 150 X 240	1
BOTTOM DRAPE REINFORCED 180 X 180	1
HAND TOWEL	2
OP TAPE	1

REF 1107	
DESCRIPTION	QTY
BACK TABLE COVER REINFORCED 150X190CM	1
MAYO STAND COVER 75X145CM	1
ADHESIVE TOP DRAPE REINFORCED 120X250CM	1
ADHESIVE BOTTOM DRAPE REINFORCED 180X180CM	1
ADHESIVE SIDE DRAPE 110 X 180 CM	2
UTILITY DRAPE WITH TAPE 26" X 15"	4
SUTURE BAG	1
ABSORBENT TOWEL	1

REF 1110	
DESCRIPTION	QTY
BACK TABLE COVER ZONAL REINFORCED	1
MAYO STAND COVER 75X145CM	1
ADHESIVE TOP DRAPE REINFORCED 150X240CM (VISCOUS)	1
ADHESIVE BOTTOM DRAPE REINFORCED 170X170CM (VISCOUS)	1
ADHESIVE SIDE DRAPE REINFORCED 75 X 90CM (VISCOUS)	2
ADHESIVE TAPE STRIP 8X50CM (VISCOUS)	1
HAND TOWEL	4
STERILE FIELD	1

REF 1108	
DESCRIPTION	QTY
BACK TABLE COVER ZONAL 150 X 210	1
SIDE DRAPE 75 X 100 (SM+PE)	2
BOTTOM DRAPE 150 X 180(SM+PE)	1
TOP DRAPE 150 X 240(SM +PE)	1
HAND TOWEL	1

5%

Basic Packs



REF 43-001

DESCRIPTION	QTY
UTILITY DRAPE 75 X 90	4
FENESTRATED DRAPE 50 X 75	1
STERILE FIELD	1

REF 43-002

DESCRIPTION	QTY
UTILITY DRAPE 75 X 90 (PE)	4
FENESTRATED DRAPE 50 X 75 (PE)	1
STERILE FIELD	1

REF 43-003

DESCRIPTION	QTY
BACK TABLE COVER REINFORCED	1
SURGICAL GOWN WRAPED WITH TOWEL (L)	1
SURGICAL GOWN WITH TOWEL (XL)	1
MAYOSTAND COVER	1
UTILITY DRAPE WITH TAPE	4
SUTURE BAG	1
HALF DRAPE	1
LARGE DRAPE	1

REF 43-004

DESCRIPTION	QTY
BACK TABLE COVER REINFORCED	1
MAYOSTAND COVER REINFORCED	1
SUTURE BAG	1
LARGE DRAPE	1

5%

ENT Pack



REF 10-418-01	
DESCRIPTION	QTY
ENT SPLIT DRAPE 180 X260	1
HEAD BAR DRAPE 120 X 150	1
SIDE DRAPE 120 X 150	1
COLLECTION POUCH 26 X 35	1
BACK TABLE COVER REINFORCED 150 X 190	1
ADHESIVE TAPE STRIP	2
MAYO STAND COVER REINFORCED	1
STERILE FIELD	1

REF 10-419	
DESCRIPTION	QTY
EENT SPLIT DRAPE 180 X260	1
BACK TABLE COVER REINFORCED 150 X 190	1
HAND TOWEL	2
MAYO STAND COVER REINFORCED	1
UTILITY DRAPES (26" X 15")	2
SUTURE BAG	1
HEAD BAR DRAPE 90 X 120	1
STERILE FIELD	1

REF 10-420	
DESCRIPTION	QTY
EENT SPLIT DRAPE 200 X300	1
HEAD BAR DRAPE 120 X 90	2
SUTURE BAG	1
HAND TOWEL	2
BACK TABLE COVER 150 X 190 FULL REINFORCED	1
MAYO STAND COVER REINFORCED	1
STERILE FIELD	1

REF 10-415	
DESCRIPTION	QTY
MAYO STAND COVER REINFORCED	1
ENT SPLIT DRAPE 180 X 250	1
HEAD BAR DRAPE 90 X 120	2
ADHESIVE TAPE STRIP	1
BACK TABLE COVER REINFORCED 150 X 190 FULL REINFORCED	1
HAND TOWEL	2
STERILE FIELD	1

REF 10-416	
DESCRIPTION	QTY
MAYO STAND COVER REINFORCED	1
EENT SPLIT DRAPE 180 X250	1
HEAD BAR DRAPE 100 X 120	1
HAND TOWEL	2
BACK TABLE COVER REINFORCED 150 X 190	1
SURGICAL GOWN LARGE	1
SUTURE BAG	1
UTILITY DRAPES (26" X 15")	2
STERILE FIELD	1

REF 10-417	
DESCRIPTION	QTY
EENT SPLIT DRAPE 180 X250	1
HEAD BAR DRAPE 90 X 120	2
ADHESIVE TAPE STRIP	1
BACK TABLE COVER REINFORCED 150 X 190	1
HAND TOWEL	2
MAYO STAND COVER REINFORCED	1
STERILE FIELD	1

REF 10-418	
DESCRIPTION	QTY
ENT SPLIT DRAPE 180 X260	1
HEAD BAR DRAPE 90 X 150	1
SIDE DRAPE 65 X 37.5	2
COLLECTION POUCH 26 X 35	1
BACK TABLE COVER REINFORCED 150 X 190	1
ADHESIVE TAPE STRIP	2
MAYO STAND COVER REINFORCED	1
STERILE FIELD	1

5%

Tur Pack



REF 46-001	
DESCRIPTION	QTY
BACK TABLE COVER 120 X 230	1
MAYO STAND COVER	1
SUTURE BAG	1
UNDER BUTTOCKS DRAPE	1
SUCTION CONNETION TUBE	1
TUR DRAPE WITH LEGGINGS 200 X 230, FLUID	1
COLLECTION POUCH ,FINGER COT	1
STERILE FIELD	1

REF 46-002	
DESCRIPTION	QTY
TUR DRAPE SAFECARE	1
HAND TOWEL	4
BACK TABLE COVER REINFORCED 150 X 190	1
STERILE FIELD	1

REF 46-003	
DESCRIPTION	QTY
BACK TABLE COVER REINFORCED 150 X 190	1
ADHESIVE TAPE STRIPS	1
HAND TOWEL	1
BNS TUR DRAPE 175/270 X 180	1
STERILE FIELD	1

REF 46-004	
DESCRIPTION	QTY
ABSORBENT TOWEL	2
UNDER BUTTOCK SHEET	1
TUR DRAPE SAFECARE	1
LEGGINGS LARGE	2
STERILE FIELD	1

5%

Shoulder Arthroscopy Pack



REF 10-021

DESCRIPTION	QTY
BACK TABLE COVER REINFORCED	1
SURGICAL GOWN LARGE WITH ABSORBENT TOWEL IN OUTER WRAP	1
SURGICAL GOWN LARGE	2
ABSORBENT TOWEL	2
MAYO STAND COVER 23X54	1
SUTURE BAG	1
UTILITY DRAPE WITH TAPE 26X15	2
SHOULDER IMPERVIOUS SPLIT DRAPE 30X45	1
SUCTION TUBING 10FT	1
BODY SPLIT DRAPE 88X116, (*) 4X27 SPLIT, (*) HEAVY DUTY FABRIC, (*) TUBE HOLDER.	1
SHOULDER ARTHOSCOPY DARPE 60X100, (*) FLUID COLLECTION POUCH, (*) HEAVY DUTY FABRIC	1
ISO -SEAL DRAPE TAPE STRIPS 5"X23.5"	2
STERILE FIELD	1

REF 10-022

DESCRIPTION	QTY
BACK TABLE COVER REINFORCED 150 X 190	1
ADHESIVE TAPE STRIPS	1
HAND TOWEL	2
MAYO STAND COVER	1
ADHESIVE DRAPE 75 X 90	1
STOCKINET	1
SHOULDER ARTHROSCOPY DRAPE 200 X300	1
STERILE FIELD	1

5%
Orthopedic Surgical Pack



REF 10-916	
DESCRIPTION	QTY
TAPE STRIPS	3
DRAPE THEATRE 150 X 120(ADHESIVE)	1
ORTHO BAR (160X260)	1
LARGE ORTHO (U)(180 X 260)	1
MAYO STAND	1
BLACK TABLE CHINA	1
UTILITY DRAPE (26"X15")	4
ABSORBENT TOWEL	4
STERILE FIELD	1

REF 10-917	
DESCRIPTION	QTY
BACK TABLE COVER	1
HAND TOWEL	2
REINFORCED SURGICAL GOWN XL	2
MAYO STAND COVER	1
SUTURE BAG	1
ADHESIVE UTILITY DRAPE	4
IMPERVIOUS SPLIT DRAPE 150 X 180	1
ADHESIVE REINFORCED DRAPE 150 X 190	1
ORTHO BAR DRAPE 160 X 260	1
ORTHO U DRAPE 180 X 260	1
WRAP	1

REF 10-922	
DESCRIPTION	QTY
BACK TABLE COVER ZOANL 150 X 210	1
HAND TOWEL	2
MAYO STAND COVER	1
IMPERVIOUS SPLIT DRAPE 130 X190 (10 X 50 SPLIT)	1
3/4 DRAPE 130 X 190	
SUTURE BAG	1
SPLIT DRAPE WITH ADHESIVE 150 X 180(10 X 150 SPLIT ON 150 SIDE)	1
SPLIT DRAPE REINFORCED 120 X220 (10 X 60 IN 120 SIDE)	1
IMPERVIOUS U DRAPE TRANSPARENT 180 X 220(10 X 60 SPLIT ON 180)	1
LARGE DARPE REINFORCED 150 X240	1
U DRAPE 220 X 280(10 X 100 SPLIT AND REINFORCEMNT WITH HOOK AND LOOP)	1
SUCTION AND DIATHERMY BAG 30 X 45	1
SUCTION TUBING 10FT	1
NEEDLE COUNTER 20 CNT FM/MG	1
OP TAPE	1
STOCKINET	1
STERILE FIELD	1

REF 10-920	
DESCRIPTION	QTY
STERILE FIELD	1
SURGICAL GOWN REINFORCED XL LONG	1
SURGICAL GOWN STD L OUTSIDE BACK TABLE COVER	1
BLACK TABLE COVER 15 X 240 ZONAL REINFORCED	1
HAND TOWL (4 LAYER BLUE)	12
SURGICAL GOWN XL STD	1
MAYO STAND COVER	1
OR TOWEL	4
LAP SPONGE 30 X30	5
STOCKINET	1
NEEDLE COUNTER 20 CNT FM/MG	1
SCALPEL NO 11	1
IV CANNULA 16G 45 MM GREY	1
KIDNEY BASIN 700 ML GOLD	1
CREPE BANDAGE 15CM (4M)	1
GAUZE 10X10(16P XRAY)	10
SUCTION TUBING 10FT	5
OP DRESSING (7 X 10)(SAFE DRESS)	8
SPLIT SHEET (150X190) PLASTIC FILM	1
OP TAPE	1
SHOULDER SPLIT SHEET (160X240) WITH POUCH	1
ABDOMINAL PAD	2
UTILITY DRAPE 90 X100	1
SIDE DRAPE REINFORCED 90 X100	1
SHOULDER SPLIT SHEET (230X245)	1
TOP DRAPE REINFORCED 120 X120	1
BOTTOM DRAPE REINFORCED 175 X 175	1
STERILE FIELD	1

5%

Knee Arthroscopy Pack



REF 35-003	
DESCRIPTION	QTY
BACK TABLE COVER - 150*190	1
TOWELS	3
REINFORCED GOWN - XL	1
MAYO TABLE COVER - 78*145	1
SUTURE BAG	1
STOCKINETTE 30*120	1
U SPLIT DRAPE 150*180	1
KNEE ARTHROSCOPY DRAPE W/ POUCH - 224*295*290	1
OPTAPE 10*50	3
WRAP 1 X 1	1

REF 35-004	
DESCRIPTION	QTY
BACK TABLE COVER - 150*190	1
TOWELS	3
REINFORCED GOWN - XL	1
MAYO TABLE COVER - 78*145	1
SUTURE BAG	1
STOCKINETTE 30*120	1
U SPLIT DRAPE 150*180	1
KNEE ARTHROSCOPY DRAPE W/ POUCH - 224*295*290	1
OPTAPE 10*50	3
REINFORCED GOWN - L	1
WRAP 1 X 1	1

REF 35-005	
DESCRIPTION	QTY
BACK TABLE COVER 150 X 190	1
HAND TOWEL	4
SUCTION TUBING 10FT	1
PREP PAD 60 X 120	1
MAYO STAND COVER	1
STOCKINET	1
OP TAPE	3
SUTURE BAG	1
REINFORCED SGOWN XL	2
REINFORCED GOWN L	1
IMPERVIOUS SPLIT DRAPE 150 X 180	1
KNEE ARTHROSCOPY DRAPE W/ POUCH - 350 X 390	1
STERILE FIELD	1

REF 35-006	
DESCRIPTION	QTY
BACK TABL ECOVER 150 X 190 FUL REINFORCED	1
ABSORBENT TOWEL	
SURGICAL GOWN LARGE	1
PREP PAD 60 X 120	1
REINFORCED SURGICAL GOWN LARGE	
MAYO STAND COVER	1
SUTURE BAG	1
SUCTION TUBING 10FT	1
IMPERVIOUS STOCKINET	1
IMPERVIOUS SPLIT SHEET	1
KNEE ARTHROSCOPY DRAPE 350 X390	1
ADHESIVE TAPE STRIPS	3
STERILE FIELD	1

5%

Procedure Pack (Radiology)



REF 1001

DESCRIPTION	QTY
BACK TABLE COVER 140 X 210	1
SWAB N.W. 10 X 10 CM 4 PLY 5 PACK	10
FLUOROSCOPY COVER 100 X 100	2
MOSQUITO ARTERY FORCEPS STRAIGHT 13 CM	1
SCISSORS SHARP/BLUNT 13 CM	1
SYRINGE 10ML L/L	2
SYRINGE 5 ML L/L	1
SYRINGE 5 ML L/S	1
BOWL 500ML	3
GUIDEWIRE BOWL	1
NEEDLE COUNTER	1
INJECTION TRAY	1
TRAY HALF DEEP 20 CM X 15 CM	1
OR TOWEL	10
FLO SWITCH	1
LABEL SET	2
SYRRINGE 10 ML WHITE L/L	1
SYRRINGE 10 ML BLUE L/L	1
SYRRINGE 10 ML RED L/L	1
DRAPE ADHESIVE 150 CM X 190 CM	1
DRAPE ADHESIVE 90 X 75	4
NEEDLE 18G X 1.5"	1
NEEDLE 18G X 7 CM (INTRODUCER)	1
ANGIO DRAPE	1
FORCEPS ARTERY MOSQUITO CURVED	1
SCALPEL NO. 11	1
NEEDLE 25G X 1.5"	1
FLUID COLLECTION DEVICE	1
GALLIPOT 120 ML	1
STERILIZATION MARKER WITH RULER	1



5%

Minor Procedure Pack (Radiology)



REF 1002	
DESCRIPTION	QTY
TABLE COVER 140 X 190 CM BLUE	1
SWAB N.W. 10 X 10 CM 4 PLY 5 PACK	6
NEEDLE 18G X 3.8 CM HYPO PINK	2
FORCEPS ARTERY MOSQUITO STRAIGHT	1
SYRINGE 20ML L/L	2
LABEL SET	1
SYRINGE 10ML L/L	2
DRAPE DS2 1 X 10CM FEN 120 CM X 150 CM	1
OR TOWEL BLUE	3
NEEDLE 25G X 3.8CM ORANGE	1
SCISSORS SHARP/BLUNT 13 CM	1
FORCEPS ARTERY MOSQUITO CURVED	1
SCALPEL NO. 11	1
TRAY HALF DEEP 26 CM X 36 CM	1
GALLIPOT 120 ML	2

REF 1002-01	
DESCRIPTION	QTY
GAUZE SPONGE 10X10 4PLY N/W N/STERILE	30
TRAY 2500ML	1
BACK TABLE COVER 140X210 CM REINFORCED N/S	1
ARTERY FORCEPS MOSQUITO 5" CURVED	1
ARTERY FORCEPS MOSQUITO 5" STRAIGHT	1
SYRINGE 10ML W/O NEEDLE LUER LOCK	2
MEDICINE CUP PP 120ML	2
ADSON TWEEZERS	1
DRESSING SCISSOR SHARP/BLUNT	1
SURGICAL BLADE NO.11	1
OR TOWEL BLUE N/STERILE	3
MEDICAL LABEL	
SYRINGE 20ML W/O NEEDLE LL	2
REINFORCED FENESTRATED DRAPE 150 X 120	
DISPOSABLE NEEDLE 18GX1.5	2
DISPOSABLE NEEDLE 25GX1.5	1

REF 1002-02	
DESCRIPTION	QTY
GAUZE SPONGE 10X10 4PLY N/W 5PCS/BUNDLE N/STERILE	4
BACK TABLE COVER 140X210 CM REINFORCED N/S	1
TRAY 2500ML	1
ARTERY FORCEPS MOSQUITO 5" CURVED	1
NEEDLE HOLDER FORCEPS 5"	1
SYRINGE 10ML W/O NEEDLE LUER LOCK	2
MEDICINE CUP PP 60ML	1
ADSON TWEEZERS 1:2	1
DRESSING SCISSOR SHARP/SHARP 13CM	1
SURGICAL BLADE NO.11	1
OR TOWEL BLUE N/STERILE	3
SYRINGE 20ML W/O NEEDLE LL,#111115	2
DISPOSABLE NEEDLE 18GX1.5 100/BX	2
DISPOSABLE NEEDLE 25GX1.5 100/BX	1
3 WAY STOP COCK	1
POLY DRAPE 150X220	1
NARROW ADHESIVE DRAPE 75X90	4
SYRINGE 5ML W/O NEEDLE LL	1
GALLIPOT 120ML	1
CSR WRAP 80X80CM	1
MEDICAL LABEL	1
BANDED BAG 100X100 CM	1

REF 1002-03	
DESCRIPTION	QTY
BACK TABLE COVER 140X210 CM REINFORCED N/S	1
TRAY 2500ML	1
ARTERY FORCEPS MOSQUITO 5" CURVED	1
ARTERY FORCEPS MOSQUITO 5" STRAIGHT	1
TERUMO SYRINGE 10ML WITHOUT NEEDLE	2
LUER LOCK (PHILIPPINES)	
ADSON TWEEZERS 1:2	1
DRESSING SCISSOR SHARP/BLUNT	1
SURGICAL BLADE NO.11	1
OR TOWEL BLUE N/STERILE	4
TERUMO SYRINGE 20ML WITHOUT NEEDLE	2
LUER LOCK (PHILIPPINES)	
DISPOSABLE NEEDLE 18GX1.5 100/BX	2
DISPOSABLE NEEDLE 25GX1.5 100/BX	1
3 WAY STOP COCK	1
POLY DRAPE 150X220	1
ADHESIVE POLY DRAPE 75X90	4
TERUMO SYRINGE 5ML WITHOUT NEEDLE	2
LUER LOCK (PHILIPPINES)	
GALLIPOT 120ML	2
CSR WRAP 100X100CM	1
MEDICAL LABEL	1
BANDED BAG 100X100 CM	1
DISPOSAL BOWL 500ML	2
GAUZE SPONGE 10X10 4PLY N/W 5PCS/BUNDLE N/STERILE	4
SYRINGE 10ML LUER SLIP W/O NEEDLE(CATHETER TIP)	1
REINFORCED FENESTRATED DRAPE 150 X 120	1

5%

Ophthalmic Pack



REF 33-002	
DESCRIPTION	QTY
BACK TABLE COVER REINFORCED 140 X150	1
OPHTHALMIC DRAPE WITH TWO POUCHES AND 10 X 10 APERTURE WITH 3 X 6 ICISE PUNCHED	1
TEGARDEM 1628	1
TRAY 4000 ML	1
TRAY 2500 ML	1
SYRINGE 3ML L\L	3
SYRINGE 30 ML	1
NEEDLE 18G 1.5"	1
NEEDLE 27G 0.5"	1
GAUZE N\W 10 X10	20
EYE SHIELD	1
EYE PAD	1
KIDNEY BASIN 700 ML (GOLD)	1
BOWL 250 ML	2
INSTRUMENT WIPE	1
ARTERY FORCEPS STRAIGHT	4
MEDICAL LABEL	1
STERILE FIELD	1

REF 33-002-01	
DESCRIPTION	QTY
BACK TABLE COVER REINFORCED 140 X150	1
OPHTHALMIC DRAPE WITH TWO POUCHES AND 10 X 10 APERTURE WITH 3 X 6 ICISE PUNCHED	1
STERILE FIELD	1

REF 33-003	
DESCRIPTION	QTY
BACK TABLE COVER REINFORCED 150 X 190	1
SURGICAL GOWN LARGE	2
EYE DRAPE 100 X 90	1
HAND TOWEL	1
MEDICINE CUP 120 ML	1
SYRINGE 3ML L\L	1
SYRINGE 5ML L\L	1
SYRINGE 10 ML L\L	1
STERILE FIELD	1

5%

Delivery Pack



REF 32-119	
DESCRIPTION	QTY
BACK TABLE COVER ZONAL REINFORCED 140 X 210	1
UNDERBUTTOCKS DRAPE	1
BABY BLANKET	1
LEGGINGS	2
ADHESIVE DRAPE 75 X 90	1
THREAD GAUZE 10 X 10	10
CORD CLAMP	2

REF 32-123	
DESCRIPTION	QTY
BACK TABLE COVER REINFORCED 150 X 190	1
HAND TOWEL	1
BABY BLANKET	1
SURGICAL GOWN REINFORCED LARGE	1
LEGGINGS WITH CUFF	2
ABDOMINAL DRAPE REINFORCED 100 X150	1
CORD CLAMP	2
VAGINAL TAMPTON	1
MATERNITY PAD	2
BULB SYRINGE	1
SMALL TRAY (800 ML)	1
PLACENTA BASIN (2500 ML)	2
STERILE FIELD	1

REF 32-124	
DESCRIPTION	QTY
BACK TABLE COVER REINFORCED 150 X 190	1
UNDERBUTTOCKS DRAPE WITH POUCH	1
BULB SYRINGE	1
HAND TOWEL	2
BABY BLANKET	1
SURGICAL GOWN REINFORCED LARGE	2
LEGGINGS WITH CUFF	2
ABDOMINAL DRAPE REINFORCED 100 X150	1
CORD CLAMP	1
VAGINAL TAMPTON	1
MATERNITY PAD	2
LAPSPONGE 30 X30	5
GAUZE THREAD XRAY 10X10	10
PLACENTA BASIN (2500 ML)	1
WRAPPER 60 X 60	1
WRAPPER 110 X120	1
STERILE FIELD	1

REF 32-124-01	
DESCRIPTION	QTY
BACK TABLE COVER REINFORCED 110 X 180	1
UNDERBUTTOCKS DRAPE WITH POUCH	1
BULB SYRINGE	1
HAND TOWEL	2
SET UP COVER 100 X 195	1
BABY BLANKET	2
SURGICAL GOWN REINFORCED LARGE	2
LEGGINGS WITH CUFF	2
ABDOMINAL DRAPE REINFORCED 100 X150	1
CORD CLAMP	1
VAGINAL TAMPTON	1
MATERNITY PAD	2
LAPSPONGE 30 X30	5
GAUZE THREAD XRAY 10X10	10
PLACENTA BASIN (4500 ML)	2
WRAPPER 60 X 60	1
WRAPPER 110 X120	1
STERILE FIELD	1

REF 32-125	
DESCRIPTION	QTY
BACK TABLE COVER REINFORCED 150 X 190	1
SURGICAL GOWN REINFORCED LARGE	1
HAND TOWEL	1
LEGGINGS WITH CUFF	2
UNDERBUTTOCKS DRAPE WITH POUCH	1
ABDOMINAL DRAPE REINFORCED 100 X150	1
BABY BLANKET	1
MATERNITY PAD	1
BULB SYRINGE	1
CORD CLAMP	1
GAUZE THREAD XRAY 10X10	20
VAGINAL TAMPTON	1
PLACENTA BASIN (2500 ML)	1
SMALL TRAY (800 ML)	1
SUTURING TRAY	1
STERILE FIELD	1

REF 32-125-01	
DESCRIPTION	QTY
BACK TABLE COVER REINFORCED 150 X 190	1
HAND TOWEL	1
SURGICAL GOWN REINFORCED LARGE	1
LEGGINGS WITH CUFF	2
UNDERBUTTOCKS DRAPE WITH POUCH	1
ABDOMINAL DRAPE REINFORCED 100 X150	1
BABY BLANKET	1
MATERNITY PAD	2
BULB SYRINGE	1
CORD CLAMP	1
VAGINAL TAMPTON	1
PLACENTA BASIN (2500 ML)	2
SUTURING TRAY	1
STERILE FIELD	1

REF 32-125-02	
DESCRIPTION	QTY
BACK TABLE COVER REINFORCED 110 X 180	1
HAND TOWEL	1
SURGICAL GOWN REINFORCED LARGE	1
LEGGINGS WITH CUFF	2
UNDERBUTTOCKS DRAPE WITH POUCH	1
ABDOMINAL DRAPE REINFORCED 100 X150	1
BABY BLANKET	2
MATERNITY PAD	2
BULB SYRINGE	1
CORD CLAMP	1
GAUZE THREAD XRAY 10X10	20
VAGINAL TAMPTON	1
PLACENTA BASIN (2500 ML)	2
SUTURING TRAY	1
STERILE FIELD	1

5%

Delivery Pack

REF 32-126	
DESCRIPTION	QTY
BACK TABLE COVER	1
REINFORCED 150X190CM	
HAND TOWEL	4
SURGICAL GOWN REINFORCED LARGE	1
SURGICAL GOWN REINFORCED X-LARGE	1
SET UP COVER - 100 X 195 (ADHESIVE)	1
UNDERBUTTOCKS DRAPE WITH POUCH	1
ABDOMINAL DRAPE REINFORCED 100 X150	1
CORD CLAMP	1
BULB SYRINGE	1
BABY BLANKET	1
LEGGINGS WITH CUFF	2
VAGINAL TAMPTON	2
MATERNITY PAD	1
GAUZE 10 X10 XRAY	5
PLACENTA BASIN (2500 ML)	3
LAPSPONGE 22.5 X 22.5	5
STERILE FIELD	1

REF 32-127	
DESCRIPTION	QTY
BACK TABLE COVER	1
REINFORCED 150X190CM	
SURGICAL GOWN REINFORCED LARGE	1
SET UP COVER 100 X 195	1
UNDERBUTTOCKS DRAPE WITH POUCH	1
ABDOMINAL DRAPE REINFORCED 100 X150	1
HAND TOWEL	2
CORD CLAMP	1
BULB SYRINGE	1
BABY BLANKET	1
LEGGINGS WITH CUFF	2
VAGINAL TAMPTON	1
MATERNITY PAD	1
PLACENTA BASIN (2500 ML)	1
GAUZE THREAD XRAY 10X10	10
STERILE FIELD	1

REF 32-127-01	
DESCRIPTION	QTY
BACK TABLE COVER ZONAL	1
REINFORCED 150X190CM	
SURGICAL GOWN STANDARD LARGE	1
SET UP COVER 100 X 195	1
UNDERBUTTOCKS DRAPE WITH POUCH	1
ABDOMINAL DRAPE REINFORCED 100 X150	1
HAND TOWEL	3
CORD CLAMP	1
BULB SYRINGE	1
BABY BLANKET	1
LEGGINGS WITH CUFF	2
VAGINAL TAMPTON	1
MATERNITY PAD	1
PLACENTA BASIN (2500 ML)	1
GAUZE THREAD XRAY 10X10	10
LAP SPONGE XRAY 30 X 30	5
STERILE FIELD	1

REF 32-129	
DESCRIPTION	QTY
BACK TABLE COVER	1
REINFORCED 150 X 190	
REINFORCED GOWN L	1
SIDE DARPE ADHESIVE ONLY 100 X150	1
UNDER BUTTOCKS DRAPE WITH POUCH	1
ABDOMINAL DRAPE REINFORCED 100 X150	1
LEGGINGS	2
BABY BLANKET	1
HAND TOWEL	4
GAUZE 10 X 10 N/W	10
CORD CLAMP	1
BULB SYRINGE	1
VAGINAL SPONGE	2
PLACENTA BASIN	3
MATERNITY PAD	1
STERILE FIELD	1

REF 32-130	
DESCRIPTION	QTY
BACK TABLE COVER REINFORCED 150 X 190	1
UNDER BUTTOCKS DRAPE WITH POUCH	1
ABDOMINAL DRAPE REINFORCED 100 X150	1
LEGGINGS	2
SET UP COVER 100 X 195	1
HAND TOWEL	2
GAUZE 10 X 10 N/W (ABSORBENT CLOTH)	10
CORD CLAMP	1
BULB SYRINGE	1
VAGINAL SPONGE	1
PLACENTA BASIN	1
MATERNITY PAD	1
BABY BLANKET	1
STERILE FIELD	1

REF 32-132	
DESCRIPTION	QTY
BACK TABLE COVER REINFORCED 150 X 190	1
UNDER BUTTOCKS DRAPE WITH POUCH	1
ABDOMINAL DRAPE REINFORCED 100 X150	1
LEGGINGS	2
SURGICAL GOWN REINFORCED LARGE	2
HAND TOWEL	2
VAGINAL SPONGE	1
SPONGE STICKS	6
LAP SPONGE 30 X 30 PRE-WASHED	2
GAUZE 10 X 20 XRD	10
120 ML GALLIPOT	3
MATERNITY PAD	4
BULB SYRINGE	1
BABY BLANKET	1
STERILE FIELD	1

REF 32-133	
DESCRIPTION	QTY
BACK TABLE COVER REINFORCED 150 X 190	1
SURGICAL GOWN REINFORCED LARGE	1
UNDER BUTTOCKS DRAPE	1
WITH POUCH (SAFECARE- DAANAT)	
ABDOMINAL DRAPE REINFORCED 100 X150	1
BABY BLANKET	1
HAND TOWEL	1
CORD CLAMP	1
SET UP COVER 120 X 150 (FULL ADHESIVE)	1
PLACENTA BASIN 2500 ML	2
MATERNITY PAD	2
STERILE FIELD	1

5%

Perineal Suture Pack



REF 32-120	
DESCRIPTION	QTY
BACK TABLE COVER 150 X 190 FULLY REINFORCED	1
HAND TOWEL	
STD GOWN LARGE	1
UNDER BUTTOCKS DRAPE WITH POUCH	1
LAP SPONGE 30 X 30 XRD	1
NEEDLE HOLDER	2
SCISSORS UMBILICAL	1
ARTERY CURVED	2
ADSON TWEEZERS TOOTHED	1
ADSON TWEEZERS	2
VAGINAL TAMPON	1
MATERNITY PADBOWL 1000 ML	1
LITHOTOMY DRAPE	2
STERILE FIELD	1

REF 60-002	
DESCRIPTION	QTY
BACK TABLE COVER 150 X 190 FULLY REINFORCED	1
HAND TOWEL	2
REINFORCED GOWN LARGE	1
UNDER BUTTOCKS DRAPE WITH POUCH	1
NEEDLE COUNYER 20 CNT	1
BOWL 250 ML	1
LAP SPONGE 45 X 45 XRD	5
ABDOMINAL DRAPE REINFORCED 100 X150	1
LEGGINGS	2
STERILE FIELD	1

5%

OB Pack



REF 60-003

DESCRIPTION	QTY
BACK TABLE COVER REINFORCED 150X210CM	1
REINFORCED GOWN LARGE	1
HAND TOWEL	2
ABDOMINAL DRAPE REINFORCED 100 X150	1
LEGGINGS	2
NEEDLE COUNTER 20 COUNT FM +MG	
BOWL 250 ML	
UNDER BUTTOCKS DRAPE	
LAP SPONGE 30 X 30 XRD PRE-WASHED	
STERILE FIELD	

REF 55-001

DESCRIPTION	QTY
BACK TABLE COVER REINFORCED 150X190CM	1
LEGGINGS WITH CUFF	2
ECG ELECTRODES	1
NORMAL SALINE 500G BOTTLE	1
HAND TOWEL	1
GAUZE 10 X10 N/W 5 PACK	2
SPINAL NEEDLE 18G 7CM	1
18 G NEEDLE 1.5"	1
UNDERPAD 60 X 90	1
OXYGEN MASK	1
SYRINGE 20 ML L/L	1
TRANSOFIX	1
STERILE FIELD	1

REF 32-121

DESCRIPTION	QTY
BACK TABLE COVER 150 X 190 FULLY REINFORCED	1
HAND TOWEL	2
STD GOWN LARGE	1
UMBILICAL SCISSORS	1
UNDER BUTTOCKS DRAPE WITH POUCH	1
NEEDLE HOLDER	2
KIDNEY DISH 700 ML GOLD	1
CORD CLAMP	1
BULB SYRINGE	1
GAUZE 4" X20"	1
BOWL 500 ML	1
LAP SPONGE 30 X 30 XRD	5
BABY BLANKET	1
MATERNITY PAD	1
DRAPE THEATER 75 X 75	1
LITHOTOMY DRAPE	1
LEGGINGS WITH CUFF	1
STERILE FIELD	1

REF 60-001

DESCRIPTION	QTY
BACK TABLE COVER 150 X 190 ZONAL REINFORCED	1
HAND TOWEL	2
REINFORCED GOWN LARGE	1
LEGGINGS	2
UNDER BUTTOCKS DRAPE WITH POUCH	1
ABDOMINAL DRAPE REINFORCED 100 X150	1
BABY BLANKET	1
MATERNITY PAD	1
BULB SYRINGE	1
GAUZE 10 X 10 XRD	20
	1
PLACENTA BASIN 2500 ML	20
STERILE FIELD	1
	1
	1

5%

OPU Pack



REF 55-001

DESCRIPTION	QTY
BACK TABLE COVER REINFORCED 150X190CM	1
LEGGINGS WITH CUFF	2
ECG ELECTRODES	1
NORMAL SALINE 500G BOTTLE	1
HAND TOWEL	1
GAUZE 10 X10 N/W 5 PACK	2
SPINAL NEEDLE 18G 7CM	1
18 G NEEDLE 1.5"	1
UNDERPAD 60 X 90	1
OXYGEN MASK	1
SYRINGE 20 ML L/L	1
TRANSOFIX	1
STERILE FIELD	1

Thyroid Pack



REF 58-001

DESCRIPTION	QTY
BACK TABLE COVER 150 X 190 REINFORCED	1
MAYO STAND COVER REINFORCED	1
SUTURE BAG	1
NEEDLE COUNTER 20 CNT FM/MG	1
THYROID DRAPE 180 X 260	1
STERILE FIELD	1

5%

Laparoscopy Pack



REF 10-319-10	
DESCRIPTION	QTY
BACK TABLE COVER REINFORCED 150 X190	1
OP TAPE	1
LAPROSCOPY DRAPE 175\270 X 180	1
SKIN CLOSURE STRIP	2
TRAY (800 ML)	1
MEPORE (6 X7 SAFEDRESS)	2
MEPORE (10 X7 SAFEDRESS)	2
SYRINGE 10 ML L\L	1
SYRINGE 20 ML L\L	1
VERESS NEEDLE 120MM	1
CAMERA DRAPE 18 X 250	1
HAND TOWEL	10
GAUZE 10 X 10 16P XRAY	15
CYSTO/TURP IRRIGATION SET DOUBLE	1
SUCTION CONNECTION TUBE	1
MAYO STAND COVER	1
GOWN X-LARGE WITH WRAPPER	3
SCALPEL 11	2
TUBE HOLDER	1
STERILE FIELD	1

REF 10-931	
DESCRIPTION	QTY
BACK TABLE COVER REINFORCED 150 X190	1
MAYO STAND COVER	1
NEEDLE COUNTER 20 CNT	1
TOP DRAPE REINFORCED 150 X 200	1
BOTTOM DRAPE REINFORCED 150 X 175	1
SIDE DRAPE REINFORCED 100 X 110	2
OP TAPE	1
CAMERA DRAPE 18 X 250	1
SUCTION AND DIATHERMY DRAPE	1
STERILE FIELD	1

REF 10-931-01	
DESCRIPTION	QTY
BACK TABLE COVER REINFORCED 150 X190	1
MAYO STAND COVER	1
NEEDLE COUNTER 20 CNT	1
TOP DRAPE REINFORCED 150 X 200	1
BOTTOM DRAPE REINFORCED 150 X 175	1
SIDE DRAPE REINFORCED 100 X 110	2
OP TAPE	1
SUCTION AND DIATHERMY DRAPE	1
STERILE FIELD	1

REF 10-932	
DESCRIPTION	QTY
MAYO STAND COVER	1
ADHESIVE TAPE STRIPS	1
ADHESIVE TUBE HOLDER	1
CAMERA CABLE COVER	1
LAPROSCOPY DRAPE 250/175/260 X 265	1
BACK TABLE COVER REINFORCED 150 X190	1
HAND TOWEL	4
STERILE FIELD	1

REF 10-933	
DESCRIPTION	QTY
BACK TABLE COVER ZONAL REINFORCED 150 X190	1
MAYO STAND COVER	1
TUBE HOLDER 2 X 23	1
OP TAPE	1
LAPAROSCOPY DRAPE SAFECARE (SM+PE)	1
HAND TOWEL	4
STERILE FIELD	2

REF 10-937	
DESCRIPTION	QTY
BACK TABLE COVER ZONAL REINFORCED 150 X190	1
OP TAPE	1
ADHESIVE TUBE HOLDER 2.5 X 30	1
CAMERA COVER	1
LAPAROSCOPY DRAPE SAFECARE 175 /250 X 320 (SMS)	1

5%

Eye Drape Set



REF 10-426	
DESCRIPTION	QTY
BACK TABLE COVER	1
MAY STAND COVER	1
FULL BODY OPHTHALMIC DRAPE WITH BILATERAL POUCH AND OVAL FENESTRATION 4X5CM	1
STERILE FIELD	1

REF 10-426-01	
DESCRIPTION	QTY
BACK TABLE COVER REINFORCED 150 X 190	1
MAYO STAND COVER REINFORCED	1
OPHTHALMIC DRAPE WITH OVAL FENESTRATION	1
STERILE FIELD	1

REF 10-427	
DESCRIPTION	QTY
BACK TABLE COVER REINFORCED 150 X 190	1
HAND TOWEL	2
MAYO STAND COVER REINFORCED	1
GAUZE N/W 10 X 10	20
DRAPE 150 X 190	1
EYE PAD	1
EYE DRAPE 130 X140 WITH TWO POUCHES AND 10 X 10 APERTURE WITH 5 X 7.5 INSICE HOLE	1
STERILE FIELD	1

5%

DHS Drape Set

Major Accessory Pack



REF 10-908	
DESCRIPTION	QTY
ABSORBENT TOWEL	3
IMPERVIOUS SPLIT SHEET	1
ORTHO U SHEET	1
DRAPE SHEET 150X200CM	3
MAYOSTAND COVER LARGE	1
D.H.S DRAPE - ADHESIVE INCISE AREA COLLECTION POUCH WITH DRAINAGE PORT	1
TAPE STRIPS 3"X20"	1
IMPERVIOUS STOCKINETTE LARGE	1
STERILE FIELD	1

REF 59-001	
DESCRIPTION	QTY
BACK TABLE COVER ZONAL REINFORCED 150 X 190	1
PREP TRAY (DRESSING KIT TRAY)	1
PREP SPONGE STICKS	5
GAUZE 10 X20 XRD	10
LAP SPONGE 30 X30 XRD	10
NEEDLE COUNETR 20 CNT FM/MG	1
SCALPEL NO 10	1
SCALPEL NO 21	1
TIP CLEANER	1
SUCTION TUBE 10 FT	1
YANKAUER HANDLE	1
SUTURE BAG	1
CATHETER TIP SYRINGE 50ML	1
SHARP TRANSFER TRAY	1
PITCHER 1L	1
OR TOWEL	2
STERILE FIELD	1

5%

Hip Arthroscopy Pack

Spinal Epidural Pack



REF 37-002	
DESCRIPTION	QTY
BACK TABLE COVER REINFORCED 150 X 240	1
SURGICAL GOWN LARGE WITH ABSORBENT TOWEL IN OUTER WRAP	1
REINFORCED SURGICAL GOWN XL	2
HAND TOWEL	4
MAYO STAND COVER	1
SUTURE BAG	1
STOCKINETTE 30*120	1
LARGE DARAPE	1
IMPERVIOUS SPLIT DRAPE 150 X 200	1
HIP DRAPE WITH ARMBOARD COVERS AND TUBE HOLDER 285 X 220X 315	1
YANKAUER HANDLE	1
SUCTION TUBING 10FT	1
STERILE FIELD	1

REF 37-003	
DESCRIPTION	QTY
BACK TABLE COVER 150 X 190	1
MAYO STAND COVER	1
SUTURE BAG	1
IMPERVIOUS STOCKINET	1
IMPERVIOUS SPLIT DRAPE 150 X200	1
HIP DRAPE WITH ARMBOARD COVERS AND TUBE HOLDER 285 X 220X 315	1
STERILE FIELD	1

REF 38-001	
DESCRIPTION	QTY
GALLIPOT 60ML	1
TRAY 2500 ML	1
FENESTRATED DRAPE 100 X70 CM	1
YELLOW BAG WITH TIE	1
GAUZE 10 X10 THREAD 8 PLY	10
ADHESIVE SHARP DISPOSAL PAD (SAFECARE)	1
STERILE FIELD	1

5%

Angio Pack



REF 16-002	
DESCRIPTION	QTY
ANGIO DRAPE	1
BACK TABLE COVER	1
REINFORCED GOWN XL	2
FLUOROSCOPY COVER 70X120	1
PEDAL COVER 60X60	1
DIATHERMY BAG 25 X 55 CM	1
TOWELS	8
GAUZE SPONGE 7.5X7.5	20
PVP SPONGE WITH STICK	1
SCALPEL NO.11	1
SOLUTION BOWL 2500 CC	1
3 PORT MANIFOLD SET	1
RIGHT HAND /OFF	
GUIDEWIRE J TIP	1
SYRINGE WITH NEEDLE LL 10 ML	2
SYRINGE WITH NEEDLE LL 20 ML	1
SELDINGER NEEDLE 18G 7 CM	1
POWDERD STERILE SURGICAL GLOVE 7	1
POWDERD STERILE SURGICAL GLOVE 7.5	2
POWDERD STERILE SURGICAL GLOVE 8	1
SYRINGE WITH NEEDLE LS 1 ML	1
SYRINGE WITH NEEDLE LS 2 ML	1

REF 16-001	
DESCRIPTION	QTY
4 WAY STOPCOCK WHITE	1
SCALPEL 11	1
BANDE BAG 100 X 100	2
3 ML SYRRINGE LL	3
5 ML SYRINGE LL	3
10 ML SYRINGE LL	4
20 ML SYRINGE LL	4
NEEDLE COUNTER	1
ANGIO DDRAPE 360 X 250 4 HOLES	1
HYPODERMIC NEEDLE 18 G	2
HYPODERMIC NEEDLE 21 G	2
HYPODERMIC NEEDLE 23 G	2
HYPODERMIC NEEDLE 25 G	2
PUNCTURE NEEDLE 18 G 7CM	1
DISPOSIBLE TOWEL	6
BLUE TOWEL (OR) 60 X 40	6
GUAZE 10 X 10 16 PLY	50
REINFORCED GOWN XL WITH TOWEL	1
OUTER WRAP	
REINFORCED GOWN L WITH TOWEL	2
HAND TOWEL	2
BOWL 250 ML	2
BOWL 500 ML	2
BOWL 1000 ML	1
BASIN 6000 ML	1
KIDNEY DISH 700 ML	1
SKIN MARKER	1
LABEL	1
MOSQUITO FORCEPS (NEEDLE HOLDER)	1
SCISSORS	1
INSTRUMENT COVER 140 CM	1
TRAY 26 X 30 X 11	1
TABLE COVER 150 X 200 CM	1
SPONGE STICK	6
LAPARATHOMY GAUZE 50 X 50	6
STERILE FIELD	1

REF 16-004	
DESCRIPTION	QTY
BACK TABLE COVER 140 X 210	1
BANDED BAG 100 X 100	1
BANDED BAG 60 X 60	3
SYRINGE 20 ML L/L	2
SYRINGE 10 ML L/L	4
SYRINGE 5 ML L/L	2
SYRINGE 3 ML L/L	2
NEX CHLOREX 3ML CLEAR	2
POVIDONE IODINE SOLUTION (AMEYA)	1
PREP SPONE STICK	4
NEEDLE 21 G 1.5"	2
NEEDLE 23G 1.5"	1
NEEDLE 27G 0.5"	1
GAUZE N/W 10 X10 (10 PACK)	3
BOWL 250 ML	2
BOWL 500ML	1
BOWL 2500ML	1
RING BASIN 6000ML	1
TRAY 2500 ML	1
NEEDLE COUNTER 20 COUNT FM +MG	1
WATER PROOF MEDICAL LABEL SET	1
MOSQUITO FORCEPS CURVED	1
SCISSORS SHARP/ BLUNT	1
TOWEL CLAMP	4
OR TOWEL	3
ANGIO DRAPE 4 HOLES	1
SALPEL NO. 11	1
ADHESIVE DRAPE 50 X75	1
MEDIUM DRAPE REIMFORCED 180 X 180	2
LARGE DRAPE REINFORCED 150 X 240	1
STERILE FIELD	1

5%

Angio Pack

REF 16-005	
DESCRIPTION	QTY
STOPCOCK 3 WAY	1
SCALPEL NO.11	1
BANDED BAG 60 X 60	2
SYRINGE COLORED WHITE - 10ML L/L	1
SYRINGE COLORED BLUE - 10ML L/L	1
SYRINGE COLORED RED - 10ML L/L	1
SYRINGE COLORED WHITE - 5ML L/L	1
SYRINGE COLORED BLUE- 5ML L/L	1
SYRINGE COLORED RED - 5ML L/L	1
SYRINGE 3ML LL	1
SYRINGE 5ML LL	1
SYRINGE 10ML LL	1
SYRINGE 20ML LL	1
NEEDLE 18G	2
NEEDLE 21G	2
NEEDLE 23G	2
NEEDLE 25G	2
NEEDLE COUNTER 20 CNT (FM+MG)	1
OR TOWEL - XRAY	6
SWAB GAUZE 10 X 10CM N/W	10
REINFORCED GOWN LARGE	1
REINFORCED GOWN X LARGE	2
HAND TOWEL	6
KIDNEY BASIN	1
RING BASIN	1
BOWL 1000ML	1
BOWL 500ML	2
GALLIPOT 120ML	2
SKIN MARKER WITH RULER	1
MEDICAL LABEL	1
FORCEPS ARTERY MOSQUITO STRAIGHT	1
SCISSORS SHARP	1
BANDED BAG 100X100	1
MAYO STAND COVER	1
SPONGE STICK	6
CSR WRAP	1
ANGIO DRAPE - 2 HOLE	1
GUIDEWIRE BOWL	1
SWAB GAUZE 45 X 45CM	6
DISPOSABLE TOWEL CLAMP	6

REF 16-006	
DESCRIPTION	QTY
STOPCOCK 3 WAY	1
3 PORT MANIFOLD	1
ADMIN SET 72" WITH VENTED FILTER (IV SET)	2
12 ML ANGIOGRAPHY SYRINGE	1
SCALPEL NO. 11	1
BANDED BAG 100 X 100	1
SYRINGE 10 ML L/L	6
SYRINGE 3 ML L/L	3
SYRINGE 20 ML L/L	2
ANGIO DRAPE 4 HOLES	1
NEEDLE 18G 1.5"	2
NEEDLE 21G 1.5"	2
NEEDLE 23G 1.5"	2
NEEDLE 25G 1.5"	2
PUNCTURE NEEDLE 18 G 7CM	1
PREP SPONE STICK	3
TOWEL CLAMP	4
OR TOWEL	7
GAUZE THREAD NXRD 10 X 10	40
REINFORCED GOWN XL	2
HAND TOWEL	2
BOWL 250ML	2
BOWL 500 ML	1
TRAY 2500 ML	1
GIIDEWIRE BOWL	1
KIDNEY BASIN 700ML GOLD	2
STERILE SKIN MARKER WITH RULER	1
MEDICAL LABEL SET WATER PROOF	1
BACK TABLE COVER REINFORCED 150 X190	1
PT 72 " M/F (HIGH PRESSURE LIN E150CM)	1
STERILE FIELD	1

REF 16-008	
DESCRIPTION	QTY
BACK TABLE ZONAL COVER	1
REINFORCED 150 X190	
BANDED BAG 120 X 120	1
BANDED BAG 90 X 90	1
MANIFOLD 3 PORT	1
HAND TOWEL	1
SURGICAL GOWN REINFORCED XL	1
ANGIOGRAPHY DRAPE 4 HOLE 200 X 310	1
STERILE FIELD	1

REF 16-009	
DESCRIPTION	QTY
BACK TABLE ZONAL COVER	1
REINFORCED 150 X210	
GUIDEWIRE J TIP	
SYRINGE 3 ML L/L	
SYRINGE 20 ML L/L	
NEEDLE 18 G 1.5"	
NEEDLE 23 G 1.5"	
NEEDLE 18G 7CM INTRODUCER	
TOWEL CLAMP	
GAUZE 10 X 10 N/W 5 PACK	
HAND TOWEL	
500 ML BOWL	
KIDNEY DISH 700 ML	
BANDED BAG 90 X 90	
SHARP/BLUNT SCISSORS	
NEEDLE HOLDER	
SCALPEL NO;11	
BANDED BAG 100 X 100	
SYRINGE 10 ML L/L	
SYRINGE 54 ML L/L	
OR TOWEL	
GOWN XL REINFORCED	
250 ML BOWL	
GIUIDEWIRE BOWL	
LABEL SET	
SKIN MARKER WITH RULER	
ANGIO DRAPE 2 HOLE	
STERILE FIED	

5%

Cardiovascular Pack



REF 47-002	
DESCRIPTION	QTY
BACK TABLE COVER 150 X230 REINFORCED	1
MAYO STAND COVER	1
CARDIOVASCULAR INCISE DRAPE	1
TOP DRAPE EINFORCED 150 X240	1
ADHESIVE DRAPE 150 X200	1
NORMAL DRAPE 150 X 200	3
REINFORCED DRAPE 150X 200	1
ADHESIVE DRAPE 75 X 75	4
OR TOWEL XRD	16
LAPO SPONGE 30 X 30 XRD	20
GAUZE 10 X 20 XRD	10
SURGICAL BLADE WITH HANDLE 10	1
SURGICAL BLADE WITH HANDLE 11	1
SURGICAL BLADE WITH HANDLE 15	1
SURGICAL BLADE WITH HANDLE 20	1
SHOE COVER PLASTIC	2
SUTURE BOOTIE	6
BASIN COVER (NOT PROVIDED)	
CAUTERY PENCIL	1
SKIN MARKER AND RULER	1
MEDICAL LABEL	2
SUCTION AND DIATHERMY BAG	1
WASTE BAG	2
SUCTION TUBE 1 0 FT	1
IRRIGGATION SYRINGE CATGETER TIP 50 ML	2
NEEDLE COUNTER 40 CNT FM/MG	1
NEEDLE COUNTER 20 CNT FM/MG	1
BOWL 250 ML	1
BOWL 500 ML	3
RING BASIN 6000 ML	1
KIDNEY BASIN 700ML GOLD	1
YANKAUER HANDLE	2
BONE WAX	2
SILK SUTURE 1/0	1
TORNIQUET	1
NEEDLE HOLDER	1
JUG 1200 ML	1
10ML SYRINGE LL	1
20ML SYRINGE LL	3
STERILE FIELD	1

REF 47-003	
DESCRIPTION	QTY
BACK TABLE COVER 150 X230 REINFORCED	1
MAYO STAND COVER	1
IOBAN	3
CARDIOVASCULAR INCISE DRAPE	1
TOP DRAPE EINFORCED 150 X240	1
ADHESIVE DRAPE 150 X200	1
NORMAL DRAPE 150 X 200	3
REINFORCED DRAPE 150X 200	1
ADHESIVE DRAPE 75 X 75	4
OR TOWEL XRD	16
LAPO SPONGE 30 X 30 XRD	20
GAUZE 10 X 20 XRD	10
SURGICAL BLADE WITH HANDLE 10	1
SURGICAL BLADE WITH HANDLE 11	1
SURGICAL BLADE WITH HANDLE 15	1
SURGICAL BLADE WITH HANDLE 20	1
SHOE COVER PLASTIC	2
SUTURE BOOTIE	6
BASIN COVER (NOT PROVIDED)	
CAUTERY PENCIL	1
SKIN MARKER AND RULER	1
MEDICAL LABEL	2
SUCTION AND DIATHERMY BAG	1
WASTE BAG	2
SUCTION TUBE 1 0 FT	1
IRRIGGATION SYRINGE CATGETER TIP 50 ML	2
NEEDLE COUNTER 40 CNT FM/MG	1
NEEDLE COUNTER 20 CNT FM/MG	1
BOWL 250 ML	1
BOWL 500 ML	3
RING BASIN 6000 ML	1
KIDNEY BASIN 700ML GOLD	1
YANKAUER HANDLE	2
BONE WAX	2
SILK SUTURE 1/0	1
TORNIQUET	1
NEEDLE HOLDER	1
JUG 1200 ML	1
10ML SYRINGE LL	1
20ML SYRINGE LL	3
STERILE FIELD	1

REF 47-003	
DESCRIPTION	QTY
BACK TABLE COVER 150 X230 REINFORCED	1
MAYO STAND COVER	1
IOBAN	3
CARDIOVASCULAR INCISE DRAPE	1
TOP DRAPE EINFORCED 150 X240	1
ADHESIVE DRAPE 150 X200	1
NORMAL DRAPE 150 X 200	3
REINFORCED DRAPE 150X 200	1
ADHESIVE DRAPE 75 X 75	4
OR TOWEL XRD	16
LAPO SPONGE 30 X 30 XRD	20
GAUZE 10 X 20 XRD	10
SURGICAL BLADE WITH HANDLE 10	1
SURGICAL BLADE WITH HANDLE 11	1
SURGICAL BLADE WITH HANDLE 15	1
SURGICAL BLADE WITH HANDLE 20	1
SHOE COVER PLASTIC	2
SUTURE BOOTIE	6
BASIN COVER (NOT PROVIDED)	
CAUTERY PENCIL	1
SKIN MARKER AND RULER	1
MEDICAL LABEL	2
SUCTION AND DIATHERMY BAG	1
WASTE BAG	2
SUCTION TUBE 1 0 FT	1
IRRIGGATION SYRINGE CATGETER TIP 50 ML	2
NEEDLE COUNTER 40 CNT FM/MG	1
NEEDLE COUNTER 20 CNT FM/MG	1
BOWL 250 ML	1
BOWL 500 ML	3
RING BASIN 6000 ML	1
KIDNEY BASIN 700ML GOLD	1
YANKAUER HANDLE	2
BONE WAX	2
SILK SUTURE 1/0	1
TORNIQUET	1
NEEDLE HOLDER	1
JUG 1200 ML	1
10ML SYRINGE LL	1
20ML SYRINGE LL	3
STERILE FIELD	1

5%

Cardiovascular Pack

REF 47-004	
DESCRIPTION	QTY
BACK TABLE COVER 150 X 190	1
SYRINGE 20 ML L/L	1
BANDED BAG 100 X 100	2
SYRINGE 10 ML L/L	6
SYRINGE 5 ML L/L	3
SYRINGE 10 ML L/S	2
SYRINGE 5 ML L/S	1
NEEDLE 21G 1.5"	2
NEEDLE HOLDER 12.5 CM	1
MINI SCALPEL NO.11	1
SKIN PREP APPLICATOR (NEX CHLOREX 3ML ORANGE)	1
BOWL 6000ML	1
BOWL 1000ML	2
BOWL 500 ML	2
BOWL 250 ML	1
SCISSORS SHARP/SHARP	1
ARTERY FORCEPS CURVED	1
LAP SPONGE XRAY 45 X 45	3
GAUZE 10 X 10 XRAY PACK OF 10	8
ANGIO DRAPE 2 HOLE	1
MEDICAL LABEL SET WATER PROOF	1
ANGIO KIT (SEPARATE KIT IN STERILE POUCH)	1
PALM PAD SYRINGE	1
3 PORT MANIFOLD	1
PRESSURE MONITORING LINE 120 CM	1
IV LINE	1
CONTRAST MEDIA ADMIN LINE WITH WASTE STATION BAG	1
EXTENSION LINE 50 CM	1
LABEL TIME OUT	1
ABSORBENT PAD	1
OR TOWEL	5
NEEDLE COUNTER 20 COUNT FM +MG	1
COVER FOOT SWITCH (BANDED BAG 60 X 60)	1
ADHESIVE DRAPE 90 X75	2
FENESTRATED DRAPE 60 X 50	1
STERILE FIELD	1

REF 47-005	
DESCRIPTION	QTY
BACK TABLE COVER 150 X 190	1
HAND TOWEL	1
REINFORCED GOWN LARGE	2
REINFORCED GOWN XL	6
ANGIO DRAPE 2HOLE	3
4 PORT MANIFOLD	2
CONTRAST MEDIA SET	1
IV SET	2
PRESSUE MONITORING LINE	1
CONTRAST INJECTION LINE 20" (PRESSURE LINE)	1
GAUZE THREAD NXRD 10 X 10	1
TOWEL CLAMP	1
X RAY COVER 100 X 100	2
INTRODUCER NEEDLE 18G 7CM	2
SCALPEL BLADE NO.11	1
SPONGE STICK	1
LEAD COVER (XRAY COVER 60 X 60)	1
MOSQUITO FORCEPS CURVED	3
SYRINGE 10 ML L/L	8
SYRINGE 20 ML L/L	1
NEEDLE 16G 1.5"	1
NEEDLE 21G 1.5"	1
CHLORAPREP 3 ML	1
OR TOWEL	1
SHARP/BLUNT SCISSOR	1
NEEDLE 23G 1"	1
LABEL SET	1
BOWL 250 ML	1
BOWL 500 ML	1
BOWL 1000 ML	5
ADHESIVE DRAPE 75 X 75	1
REINFORCED DRAPE 150 X 190	1
KIDNEY BASIN 700 ML GOLD	2
RING BASIN 6000ML	1
STERILE FIELD	1

REF 47-006	
DESCRIPTION	QTY
BACK TABLE COVER 150 X 230	1
STANDARD GOWN LARGE WITH OUTER WRAP	1
HAND TOWEL	2
SURGICAL GOWN REINFORCED LARGE	2
MAYO STAND COVER	1
DRAPE 130 X 190 (NORMAL)	1
UTILITY DRAPE 60 X 50	8
SUTURE BAG	1
CARDIO VASCULAR SPLIT DRAPE (203 X 274 X 320)	1
BILATERAL SPLIT SHEET 180 X 200	1
STERILE FIELD	1

REF 47-008	
DESCRIPTION	QTY
BOWL 6000ML RING BASIN	2
BOWL 1000ML	1
CAUTERY TIP CLEANER	2
BACK TABLE COVER 150 X 230 REINFORCED	1
BILATERAL DRAPE 180 X 210 CM	1
SPLIT DRAPE 180 X 215 CM	1
SUTURE BOOT 6/PK	1
NEEDLE COUNTER 40CNT	1
SUCTION YANKAUER TIP	1
GAUZE 10 X 10	10
OP TAPE 10 X 50 CM	3
SUCTION TUBING	2
ISOLATION BAG	1
BOOT COVERS	2
BOWL 1500ML	1
KIDNEY BASIN 700 ML	1
MAYO STAND COVER	2
MEDICINE CUP 120 ML	2
BACK TABLE COVER 150 X 150 CM	2
DRAPE IRRIGATION POUCH	4
SURGICAL GOWN XL	2
MAGNETIC MAT 48 CNT	1
PEANUT SPONGES	5
SYRINGE 1 ML	1
OR TOWEL BLUE	5
TUBE HOLDER	2
GAUZE SWAB 10 X 20 XRD	10
DRAPE SHEET 180 X 240 CM	1
BOWL 250 ML	2
CAUTERY PENCIL	1
DRAPE IOBAN 13 X 13 FOIL	1
ADHESIVE DRAPE 75 X 75 CM	4
SURGICAL GOWN L	6
SUCTION CATHETER 16 FR	1
LAP SPONGE 45 X 45	25
LAP SPONGE 30 X 30	25
SYRINGE 50 ML	1
OR TOWEL	3
TOURNIQUET KIT W/ SNARE	1
DRAPE SHEET 100 X 100 CM	2
SKIN MARKER	1
GAUZE SWAB 10 X 10 XRD	10

5%

Double Basin Pack



REF 45-001	
DESCRIPTION	QTY
BOWL 1000ML	2
BULB SYRINGE 60 ML	1
TIP CLEANER	1
KIDNEY BASIN 700 ML	1
GAUZE 10X10 16 PLY XRAY	5
MEDICAL LABEL	1
LAP SPONGE 45X45 12 PLY	5
BOWL 250 ML	2
NEEDLE COUNTER 40 COUNT F/M	1
PITCHER 1.2L	1
RING BASIN 6000 ML	1
SUCTION TUBE 10FT	1
BACKTABLE COVER 150X230	1
SKIN MARKER + RULER	1

REF 45-003	
DESCRIPTION	QTY
KIDNEY BASIN 700ML	1
BULB SYRINGE 60 ML	1
BOWL 1000 ML	2
MEDICINE CUP 60ML	2
GAUZE 10X10 16PLY XRD	10
LAP SPONGE 45X45 12PLY	10
NEEDLE COUNTER 100 F/M	1
OR BASINS LIGHT BLUE	2
PITCHER 1200ML	1
CAUTERY TIP POLISHER	1
SUCTION TUBE 10FT	1
YANKAUER	1
BACK TABLE COVER 150X230 CM	1
MEDICAL LABEL	1

REF 45-002	
DESCRIPTION	QTY
SUTURE BAG	1
KIDNEY BASIN 700ML	1
SURGICAL BLADE 10	2
SURGICAL BLADE 15	1
DISPOSAL BOWL 1000ML	1
BULB SYRINGE 60 ML	1
SPECIMEN CONTAINER 120ML WITH LID	1
MEDICINE CUP 60ML	2
GAUZE 10X10 16 PLY XRD	10
LAP SPONGE 45X45 12PLY	10
MEDICAL LABEL	1
NEEDLE COUNTER 100 F/M	1
DISPOSABLE BOWL 6000ML	2
PITCHER 1200ML	1
CAUTERY TIP POLISHER	1
SKIN MARKER+RULER	1
SUCTION TUBE 10FT	1
BACK TABLE COVER 150X230 CM	1
OR TOWEL BLUE XRD	6
YANKAUER CROWN TIP VENT	1

REF 45-008	
DESCRIPTION	QTY
BACK TABLE COVER 150X190	1
HAND TOWEL	1
SUCTION TUBE 10FT	1
SKIN MARKER	1
BULB SYRINGE 60 ML LONG	1
KIDNEY BASIN 700ML	1
LAP SPONGE XRD-45X45 4PLY	5
GAUZE SWAB 10X20 XRD	5
YANKAUER SUCTION TIP	1
NDL CNTR 40 COUNT	1
INSTRUMENT CLEANER 5X5	1
JUG 1.2 L	1
BOWL 250 ML	2
BOWL 1000 ML	2
SUTURE BAG	1
MEDICAL LABEL	1
BOWL 6000 ML	1
LAP SPONGE 30X30 XRD 12 PLY	5
CSR 100X100 45GSM	1

REF 45-009	
DESCRIPTION	QTY
NEEDLE CNT 40 FM+MG	1
SUCTION TUBE 10 FT	1
YANKAUER	1
LAP 45X45 XRD 5 PCS	2
GAUZE 10X10 16PLY XRD 5PCS	2
MEDICAL CUPS 60ML	2
BULB SYRING 60ML LONG	1
CAUTERY TIP POLISHER	1
LABEL SHEET	1
SKIN MARKER	1
KIDNEY BASIN 700 ML	1
PITCHER 1200ML	1
RING BASIN 1000ML	2
RING BASIN 6000ML	2
TABLE COVER 150X190 CM	1

5%

Dental Drape Set



REF 57-001	
DESCRIPTION	QTY
STERILE FIELD	1
STERILE FENESTRATED DRAPE 80 X 80 WITH 12 X 14 FENESTRATION	1
STERILE ADHESIVE DRAPE 80 X60 (7CM LENGTH ADHESIVE ON TOP TWO SIDE)	1

Set Up Pack



REF 44-001	
DESCRIPTION	QTY
BACK TABLE COVER ZONAL REINFORCED 150 X 260	1
MAYO STAND COVER	1



لارا العربية التجارية
LARA AL ARABIA TRADING



لارا العربية التجارية
LARA AL ARABIA TRADING

CONTACT NO : +966 50 301 5849

LICENCE NO : 4030218688

ADDRESS : 7755, 2750, AHMAD AL ATTAS, AZ ZAHRA DISTRICT,
23425, JEDDAH, KINGDOM OF SAUDI ARABIA